

JENWAY

Spectrophotometer
Model 7200 & 7205

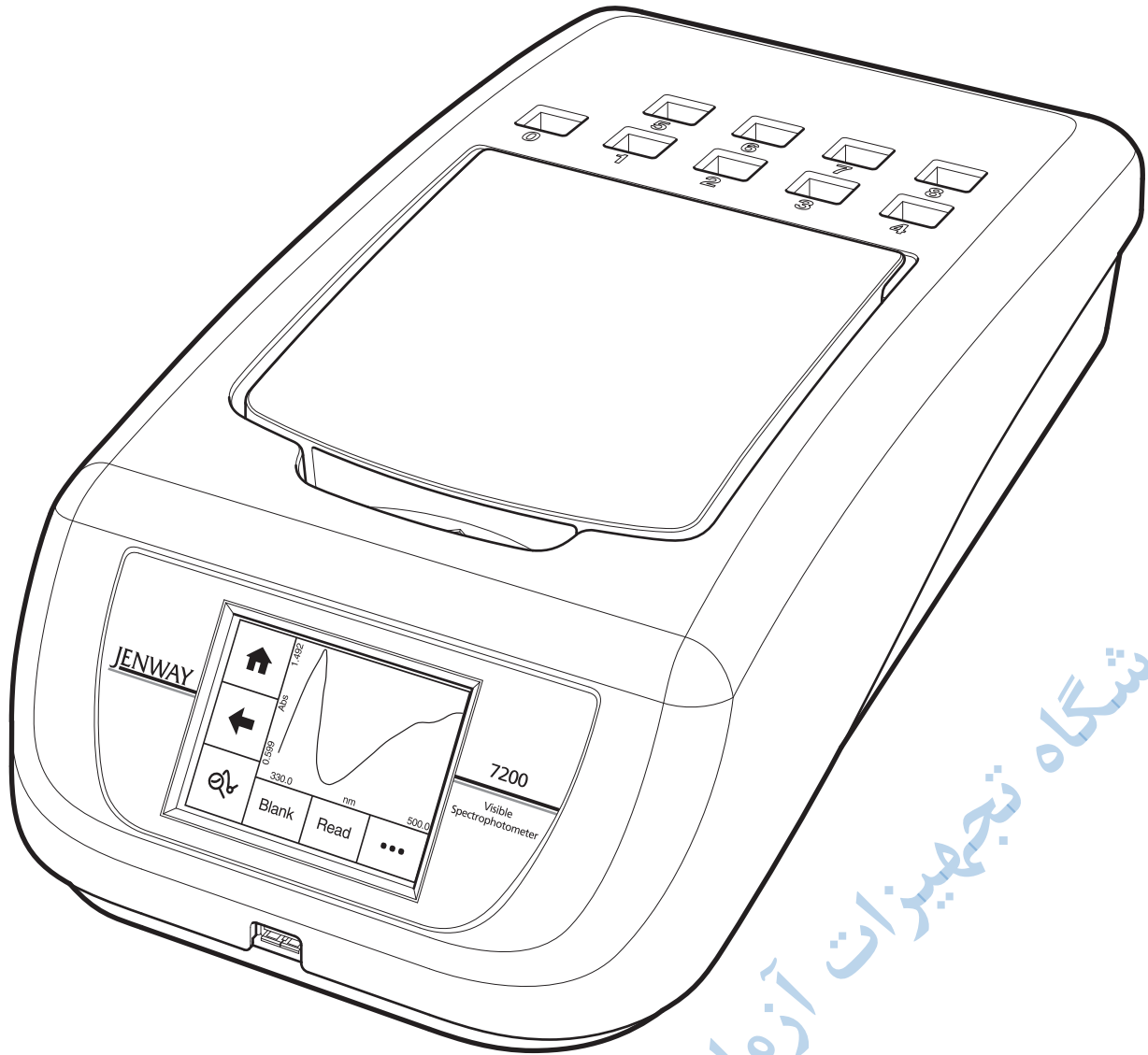



Instruction Manual
720 010/V3.0/06.18

فروشگاه تجهیزات آزمایشگاهی روناسی

فروشگاه تجهیزات آزمایشگاهی روناسو



Safety

Please read this information carefully prior to installing or using this equipment.



1. The unit described in this manual is designed to be operated only by trained personnel. Any adjustments, maintenance and repair must be carried out as defined in this manual, by a person qualified to be aware of the hazards involved.
2. It is essential that both operating and service personnel employ a safe system of work, in addition to the detailed instructions specified in this manual.
3. Other than for those items defined in the maintenance procedures herein there are no user serviceable items in this instrument. Removal of covers and attempted adjustment or service by unqualified personnel will invalidate the warranty and may incur additional charges for repair.
4. References should always be made to the Health and Safety data supplied with any chemicals used. Generally accepted laboratory procedures for safe handling of chemicals should be employed. Do not use hazardous or flammable substances in the instrument.
5. If it is suspected that safety protection has been impaired in any way, the unit must be made inoperative and secured against any intended operation. The fault condition should immediately be reported to the appropriate servicing authority.
6.  The warning symbol alerts the user to important information about using the instrument. Read and follow the associated instructions carefully.
7.  This instrument uses a UV light source. Do not look directly at the light source.
8.  **WARNING:** HIGH TEMPERATURES ARE DANGEROUS. They can cause serious burns to operators and ignite combustible material.
9. **WARNING:** If the equipment is not used in the manner specified, the protection provided by the equipment may be impaired.
10. Do not replace the detachable mains leads with inadequately rated leads.

Merci de lire attentivement ces informations avant d'installer ou d'utiliser cet appareil.

1. L'appareil décrit dans ce manuel est conçu pour être utilisé uniquement par des personnes formées. Tout réglage, maintenance ou réparation doit être effectué comme décrit dans ce manuel, par une personne qualifiée consciente des risques encourus.
2. Il est essentiel que les personnes utilisant et intervenant sur cet appareil respectent les règles de sécurité de travail, en plus des instructions détaillées précisées dans ce manuel.
3. En-dehors des éléments décrits dans les procédures de maintenance ci-incluses, cet appareil ne contient aucun élément réparable par l'utilisateur. L'enlèvement des capots et les tentatives de réglage ou de réparation par des personnes non qualifiées invalide toute garantie et entraîne un risque de frais de réparation supplémentaires.
4. Toujours se référer aux fiches techniques de santé et de sécurité accompagnant tout produit chimique utilisé. Respecter les procédures de laboratoire généralement acceptées pour la manipulation en toute sécurité des produits chimiques. Ne pas utiliser de substances dangereuses ou inflammables sur l'appareil.



5. Si l'utilisateur suspecte qu'un problème quelconque puisse mettre en cause la sécurité, l'appareil doit être rendu inopérant en empêchant son utilisation. Communiquer la défaillance constatée au service de maintenance compétent.
6.  Le symbole d'alerte signale à l'utilisateur les informations importantes concernant l'utilisation de l'appareil. Lire et suivre les instructions fournies avec la plus grande attention.
7.  Cet appareil utilise une source lumineuse UV. Ne pas regarder directement vers la source.
8.  **AVERTISSEMENT:** Les TEMPÉRATURES ÉLEVÉES SONT DANGEREUSES car elles peuvent provoquer de graves brûlures chez l'opérateur et enflammer les matériaux combustibles.
9. **ATTENTION.** Si l'appareil n'est pas utilisé de manière adéquate, la protection de l'appareil pourrait être impactée.
10. Ne pas remplacer le cordon d'alimentation fourni par un cordon d'alimentation de dimension électrique non adapté.

Bitte lesen Sie diese Hinweise vor Installation oder Gebrauch dieser Ausrüstung sorgfältig durch.

1. Das in diesem Handbuch beschriebene Gerät darf nur von geschultem Personal bedient werden. Alle Anpassungen, Wartungsarbeiten und Reparaturen müssen entsprechend der Vorgaben in diesem Handbuch und von einer kompetenten Person, die mit den damit verbundenen Gefahren vertraut ist, durchgeführt werden.
2. Es ist wichtig, dass sowohl das Bedienungs- als auch das Service-Personal zusätzlich zu den detaillierten Anweisungen in diesem Handbuch ein sicheres Arbeitssystem einsetzen.
3. Mit Ausnahme der Teile, deren Wartungsverfahren in diesem Handbuch beschrieben sind, enthält dieses Gerät keine weiteren Teile, die vom Benutzer gewartet werden können. Das Entfernen von Abdeckungen und Versuche von hierfür unqualifiziertem Personal, Anpassungen oder Wartungsarbeiten durchzuführen, haben zur Folge, dass die Garantie verfällt und können zusätzliche Reparaturkosten auslösen.
4. Es ist jederzeit auf die sicherheitsrelevanten Daten sämtlicher verwendeter Chemikalien Bezug zu nehmen. Allgemein anerkannte Labormethoden zum sicheren Umgang mit Chemikalien sollten eingesetzt werden. Verwenden Sie keine gefährlichen oder entzündlichen Stoffe in Verbindung mit dem Gerät.
5. Besteht der Verdacht, dass die Sicherheitsvorrichtungen in irgendeiner Weise beschädigt wurden, muss das Gerät außer Betrieb genommen und gegen weiteren Gebrauch gesichert werden. Die Störung sollte der zuständigen Serviceeinrichtung unverzüglich gemeldet werden.
6.  Das Warnsymbol weist auf wichtige Informationen zur Verwendung des Geräts hin. Lesen und befolgen Sie die dazugehörigen Anweisungen sorgfältig.
7.  Dieses Instrument greift auf eine UV-Lichtquelle zurück. Nicht direkt in die Lichtquelle schauen.
8.  **ACHTUNG:** HOHE TEMPERATUREN STELLEN EINE GEFAHRENQUELLE DAR. Sie können schwere Brandverletzung verursachen und brennbare Stoffe entzünden.

9. ACHTUNG: Wenn das Gerät nicht in der vorgegebenen Weise eingesetzt wird, können die Schutzfunktionen des Gerätes beeinträchtigt werden.
10. Abnehmbares Anschlusskabel nicht durch unangemessen bewertete Kabel austauschen.

Leggere attentamente queste istruzioni prima di installare o utilizzare il dispositivo.

1. L'unità descritta nel presente manuale è stata realizzata per essere utilizzata solo da personale che ha ricevuto l'apposita formazione. Qualsiasi operazione di regolazione, manutenzione e riparazione deve essere effettuata sulla base di quanto indicato nel presente manuale da personale qualificato consapevole dei rischi connessi.
2. È fondamentale che il personale operativo e il personale addetto alla manutenzione utilizzino un sistema di lavoro sicuro, oltre a seguire le istruzioni specificate nel presente manuale.
3. Oltre a quelli indicati nelle procedure di manutenzione, all'interno di questo dispositivo non sono presenti altri elementi sui quali è possibile effettuare interventi. La rimozione delle protezioni e qualsiasi tentativo di regolazione o di manutenzione posto in essere da personale non qualificato invaliderà la garanzia. In questi casi, sarà necessario pagare un importo per le riparazioni effettuate.
4. È sempre necessario fare riferimento ai dati sulla salute e sulla sicurezza forniti con le sostanze chimiche utilizzate. Adottare le procedure di laboratorio generalmente accettate per la gestione delle sostanze chimiche. Non utilizzare sostanze pericolose o infiammabili sullo strumento.
5. Nel caso in cui si sospetti che la salute possa essere pregiudicata in qualsiasi modo, disattivare l'unità per renderla inutilizzabile. Qualsiasi condizione di errore deve essere immediatamente segnalata al responsabile per la manutenzione.
6.  Il simbolo di avvertenza informa l'utente sulle informazioni importanti in merito all'uso dello strumento. Leggere e seguire le istruzioni corrispondenti con cura.
7.  Questo strumento utilizza una sorgente di luce UV. Non guardare direttamente la sorgente di luce.
8.  **AVVERTENZA:** Le ALTE TEMPERATURE SONO PERICOLOSE in quanto possono provocare serie ustioni agli operatori e dare fuoco al materiale combustibile.
9. **AVVERTENZA:** qualora il dispositivo non venga utilizzato nel modo descritto, la protezione fornita dal dispositivo stesso potrebbe risultare compromessa.
10. Non sostituire i cavi di alimentazione di rete scollegabili con cavi inadeguati.

Lea esta información atentamente antes de instalar o utilizar este equipo.

1. La unidad descrita en este manual está diseñada para que solamente la utilice personal con formación. Cualquier operación de ajuste, mantenimiento y reparación debe llevarse a cabo del modo indicado en este manual y debe realizarla una persona cualificada que sea consciente de los peligros que implica.
2. Es fundamental que tanto los operarios como el personal de servicio utilicen un sistema de trabajo seguro, así como las instrucciones detalladas que se especifican en este manual.
3. Cualquier elemento que no se encuentre entre los definidos en los procedimientos de mantenimiento aquí descritos no podrá utilizarse en este instrumento. La extracción de las tapas y los intentos de ajuste o reparación por parte de personal no cualificado invalidarán la garantía y pueden incurrir en cargos adicionales por reparación.

4. Siempre deberían consultarse los datos sobre Salud y Seguridad que se suministran con cualquier producto químico que se utilice. Es necesario llevar a cabo los procedimientos de laboratorio de aceptación generalizada para la manipulación segura de productos químicos. No utilice sustancias peligrosas o inflamables en el instrumento.

5. Si existe la sospecha de que las medidas protectoras de seguridad han quedado dañadas en cualquier modo, la unidad debe inutilizarse y protegerse contra toda operación que se intente llevar a cabo. El estado de fallo debe comunicarse inmediatamente a la autoridad de servicio de mantenimiento y reparación pertinente.

6.  El símbolo de advertencia avisa al usuario de información importante relacionada con el uso del instrumento. Lea atentamente y siga las instrucciones correspondientes.

7.  Este instrumento utiliza una fuente de luz UV. No mire directamente a la fuente de luz.

8.  ADVERTENCIA: LAS ALTAS TEMPERATURAS SON PELIGROSAS, ya que pueden ocasionar quemaduras graves a los operarios y prender el material combustible.

9. ADVERTENCIA: Si el equipo no se utiliza de la manera especificada, la protección que ofrece el aparato puede verse afectada.

10. No sustituya el cable de alimentación eléctrica con cables de voltaje inadecuado.

فروشگاه تجهیزات آزمایشگاهی روناکو

Contents

	Page
Safety	3
SECTION 1 - Introduction	11
1.1 Instrument description	11
1.2 Important safety advice	11
1.3 Instrument specification	12
SECTION 2 - Installation	13
2.1 Unpacking	13
2.2 Installation	13
2.3 Rear panel	14
2.4 Front access panel	14
2.5 Lamp access panel	15
2.6 Display	15
SECTION 3 - Theory and practice of spectroscopy measurements	16
3.1 Theory of spectroscopy measurement	16
3.2 Spectroscopy measurement	17
3.3 Good practice guidelines	17
SECTION 4 - Instrument setup	19
4.1 Navigating and screen setup	19
4.2 Instrument settings screen	19
4.3 Printing and saving	20
4.4 Heated cell accessory control	21
4.5 Date and time	22
4.6 Language	23
4.7 Software update	23
SECTION 5 - Single wavelength	25
5.1 Simple (ABS/%T) measurement mode	26
5.1.1 Method set up	26
5.1.2 Selecting a wavelength	26
5.1.3 Measurement name	27
5.1.4 Blank calibration and sample measurement	27
5.2 Optical density measurement mode	28
5.2.1 Method setup	28
5.2.2 Selecting a wavelength	29
5.2.3 Measurement name	29

فروشگاه تجهیزات آزمایشگاهی رونکو

5.2.4	Entering a factor	29
5.2.5	Entering concentration units	30
5.2.6	Blank calibration and sample measurement	30
5.3	Use a factor measurement mode	31
5.3.1	Method setup	32
5.3.2	Selecting a wavelength	32
5.3.3	Measurement name	32
5.3.4	Entering a factor	33
5.3.5	Units of measure	33
5.3.6	Blank calibration and sample measurement	33
5.4	Use standard(s) measurement mode	35
5.4.1	Method setup	35
5.4.2	Selecting a wavelength	36
5.4.3	Measurement name	36
5.4.4	Entering concentration units	36
5.4.5	Selecting the number of standards and replicates	37
5.4.6	Measuring standards	37
5.4.7	Load standard curve	39
5.5	Blank calibration and sample measurement	40
SECTION 6 - Spectrum		42
6.1	Method setup	42
6.1.1	Measurement name	42
6.1.2	Selecting measurement mode	43
6.1.3	Setting start and end wavelengths	43
6.2	Blank calibration and sample measurement	44
6.3	Data analysis	45
6.3.1	Spectrum zoom	45
6.3.2	Spectral points analysis	46
SECTION 7 - Kinetics		48
7.1	Method setup	48
7.1.1	Measurement name	49
7.1.2	Selecting number of wavelengths	50
7.1.3	Selecting measurement mode	50
7.1.4	Run time	50
7.1.5	Read interval	50
7.1.6	Lag time (seconds)	51
7.1.7	Selecting concentration units	51
7.1.8	Selecting a wavelength and factor	51
7.2	Blank calibration and sample measurement	52
7.3	Post measurement analysis	54

فروشگاه تجهیزات آزمایشگاهی روناکی

SECTION 8 - Glossary of icons	55
SECTION 9 - Accessories and spare parts	57
9.1 Optional accessories	57
9.2 Connecting the accessories	57
9.2.1 External printer	57
9.2.2 Passive accessories	57
9.2.3 Active accessories	58
9.3 Spares	58
SECTION 10 - Maintenance and service	59
10.1 Routine maintenance and cleaning	59
10.2 Lamp replacement	59
10.2.1 Halogen lamp module replacement	59
10.3 Firmware update procedure	61
10.4 Service	61
10.5 Warranty	61
SECTION 11 - Troubleshooting	62
11.1 Power up calibration failure	62
11.2 Error codes	63
11.3 Troubleshooting guide	66
11.4 Technical support	66
SECTION 12 - Declaration of conformity	67

فروشگاه تجهیزات آزمایشگاهی روناکو

فروشگاه تجهیزات آزمایشگاهی روناسو

SECTION 1 - Introduction

1.1 INSTRUMENT DESCRIPTION

Model 7200 is a visible diode array spectrophotometer which is suited to a wide range of applications in education, quality control, environmental and clinical analysis. This spectrophotometer covers a wavelength range from 335nm to 800nm, with measurement modes for photometrics, concentration, spectrum scanning, quantitation and kinetics.

Model 7205 includes all the features of the model 7200 with the added benefit of an expanded wavelength range from 198nm to 800nm to include UV applications. Both models have a touchscreen interface for easy navigation through the user interface.

This equipment is designed to operate under the following conditions:

- ❖ For indoor use only
- ❖ Use in a well ventilated area
- ❖ Ambient temperature range 5°C to 40°C (41°F to 104°F)
- ❖ Altitude to 2000 m (6500 ft)
- ❖ Relative humidity not exceeding 80%
- ❖ Mains supply fluctuations not exceeding 10% of nominal
- ❖ Overvoltage category II IEC60364-4-443
- ❖ Pollution degree 2 IEC664
- ❖ Use with a minimum distance all round of 200 mm (8 in.) from walls or other items

1.2 IMPORTANT SAFETY ADVICE

- ❖ SHOCK HAZARDS OR UNSAFE PRACTICES ARE DANGEROUS as they can cause severe personal injury, fire or death.
- ❖ DO NOT use combustible substances near hot objects.
- ❖ DO NOT use the equipment in hazardous atmospheres.
- ❖ DO NOT operate or handle any part of the product with wet hands or use on surfaces that may become flooded.
- ❖ NEVER move the product while still connected to the power supply.
- ❖ HIGH TEMPERATURES ARE DANGEROUS as they can cause serious burns to operators and ignite combustible material.
- ❖ USE CARE AND WEAR PROTECTIVE GLOVES TO PROTECT HANDS.
- ❖ NEVER lift or carry the instrument until it has been switched off and allowed to cool.
- ❖ DO NOT position the unit so that it is difficult to disconnect from the mains supply using the mains plug.
- ❖ The mains outlet socket used should be located close to the equipment and readily identifiable and accessible to users.
- ❖ DO NOT leave equipment switched on and it is not recommended to leave any heating apparatus unattended during operation.
- ❖ The unit should be carried using both hands.

1.2 INSTRUMENT SPECIFICATION

	7200	7205
Wavelength		
Range	335 to 800nm	198 to 800nm
Accuracy	± 2nm	± 2nm
Repeatability	± 2nm	± 2nm
Spectral bandwidth	7nm	5nm
Photometrics		
Transmittance	0 to 199.9%	0 to 199.9%
Absorbance	-0.300 to 2.500A	-0.300 to 2.500A
Accuracy	+/- 0.01A at 1.0A and 546nm	+/- 0.01A at 1.0A and 546nm
Stability (A)	+/- 0.005A/h at 0.04A and 546nm after 60 min warm-up	+/- 0.005A/h at 0.04A and 546nm after 60 min warm-up
Noise	+/- 0.002A at 0.04A and +/- 0.02A at 2.0A and 546nm	+/- 0.002A at 0.04A and +/- 0.02A at 2.0A and 546nm
Stray Light at 340nm, %T	<1%T according to ANSI/ASTM E387-72	<1%T according to ANSI/ASTM E387-72
Concentration		
Range	+/- 2500	+/- 2500
Calibration	Blank with a single standard or factor	Blank with a single standard or factor
Factor	+/- 1000	+/- 1000
Standard	+/- 1000	+/- 1000
Optical Density		
Factor	+/- 1000	+/- 1000
Quantitation		
Range	+/- 2500	+/- 2500
Calibration	Blank with up to 6 standards	Blank with up to 6 standards
Curve fit algorithms	Linear and linear through zero	Linear and linear through zero
Kinetics		
Measurement Time	15 to 9999 seconds	7 to 9999 seconds
Number of wavelengths	3	3
Calibration	Blank with a factor	Blank with a factor
Display	Graphical and concentration	Graphical and concentration
Analysis	Concentration	Concentration
Spectrum		
Range	335 to 800nm	198 to 800nm
Analysis	Absorbance or % transmittance and up to 50 spectral analysis points	Absorbance or % transmittance and up to 50 spectral analysis points
Other		
Beam height	15mm	15mm
Light source	Tungsten Halogen lamp	Xenon lamp
Results memory	Limited by attached mass storage device	Limited by attached mass storage device
Removable media	USB (not supplied)	USB (not supplied)
Outputs	USB x 2	USB x 2
Supply voltage/frequency	100 – 240VAC at 50 to 60Hz	100 – 240VAC at 50 to 60Hz
Power supply	12V DC, 3.8A	12V DC, 3.8A
Size (w x d x h)	212 x 422 x 120mm	212 x 422 x 120mm
Weight	2.8kg	2.8kg

SECTION 2 - Installation

2.1 UNPACKING

Remove the spectrophotometer from the packaging and ensure the following items are included:

1. Model 7200 spectrophotometer (720 001) or Model 7205 spectrophotometer (720 501)
2. 12V 3.8A power supply unit (M7980)
3. Mains Power leads UK plug (M7817UK), EU (M7817X6) and US (M7817X1)
4. Instruction manual (720 010)
5. Jenway Foreign Manual CD (JENMANCD)

2.2 INSTALLATION

Models 7200 and 7205 are supplied ready to use.

The unit should be placed on a clean flat surface which is free from drafts and vibrations. Do not position the unit so that it is difficult to access the ON/OFF switch.

Do not position the product so that it is difficult to disconnect from the mains supply using the mains plug.

The mains outlet socket used should be located close to the unit and be readily identifiable and accessible to users.

The unit and its power supply are not intended for use in environments that are moist or exposed to liquids. In the event of a local spillage or other hazard disconnect from the mains supply by removing the mains plug from the mains outlet socket.

The unit should only be used in an environment with a temperature range of 5 to 40°C and maximum relative humidity 0 to 80% for temperatures up to 31°C, decreasing linearly to 50% at 40°C. When the instrument is used for the first time or moved to a different environmental temperature, it is important to allow the instrument to equalise to the ambient temperature. Therefore allow the unit to stand for 2 hours before switching it on.

The supplied power supply unit is designed for operation on 100VAC to 240VAC input at 50 to 60Hz. Select the power lead and attach to the power supply unit. Connect the power supply unit to the power inlet socket on the rear panel of the instrument and connect to the mains socket. Ensure that the sample chamber is empty before turning the power on at the mains and switching the instrument on using the power switch on the rear of the instrument.

The instrument will perform several power-on tests and lamp calibration before displaying the main screen.

WARNING: Leaving cuvettes in the sample holder during power up will result in failure of the power on tests. Refer to Section 11 for more details.

2.3 REAR PANEL

The image below shows the rear panel on the instrument:

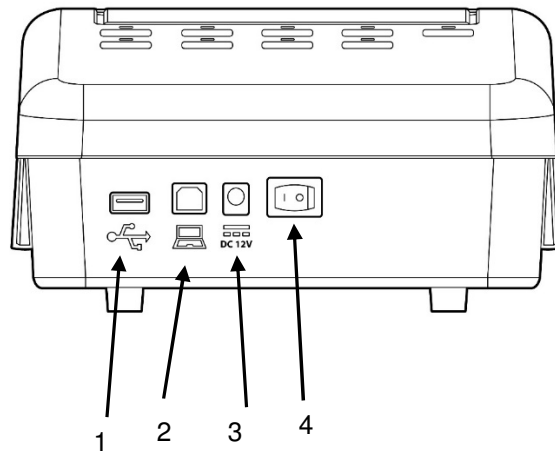

Fig. 2.3.1 – Rear Panel

1. USB port Allows connection to a USB printer
2. PC connector Allows connection to a PC
3. Power in socket Connection socket for power supply unit
4. Rocker Switch Allows the unit to be powered on or off

2.4 FRONT PANEL

The image below shows the front panel of the instrument:

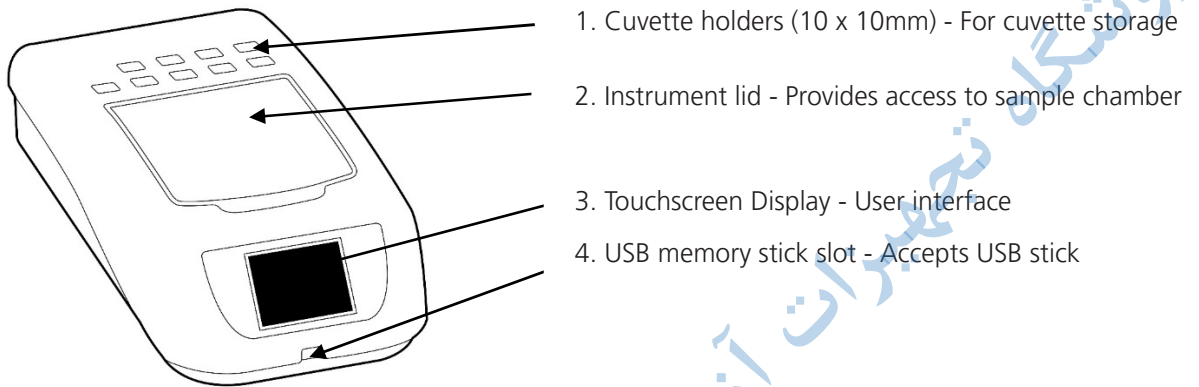

Fig. 2.4.1 – Front Panel

فروشگاه تجهیزات آزمایشگاهی روناکو

2.5 LAMP ACCESS PANEL

The image below shows the lamp access panel on the underside of the instrument:

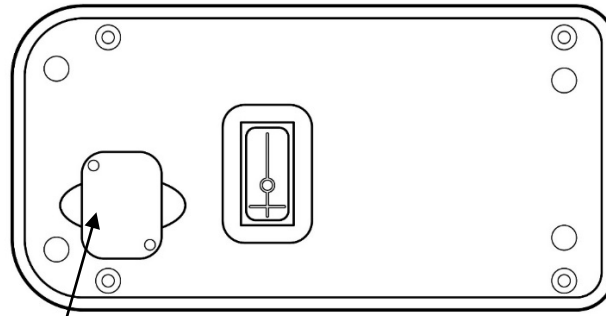

Fig. 2.5.1 – Lamp Access Panel

1

1. Lamp Access Panel Allows access to lamp when replacement is necessary



WARNING! Refer to section 10.2 for instructions on how to remove and replace the lamp.

2.6 DISPLAY

The instrument has a touchscreen display which enables easy setup and navigation of the instrument.

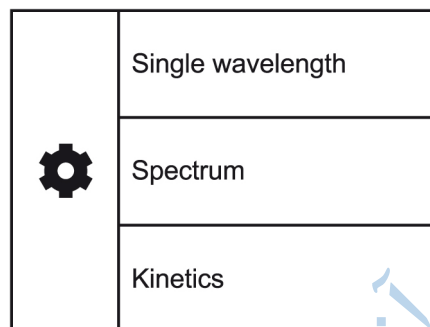



Fig. 2.6.1 – Main Screen

- Settings 
- Single Wavelength Measurement Modes
- Spectrum Measurement Mode
- Kinetics Measurement Mode

SECTION 3 – Theory and Practice of Spectroscopy Measurements

3.1 THEORY OF SPECTROSCOPY MEASUREMENT

UV-visible spectroscopy is the measurement of the absorbance of light at a specific wavelength in a sample. This is used to identify the presence and concentration of molecular entities within the sample. The Beer-Lambert law is used to relate the absorption of light to the properties of the sample through which the light is travelling through. The Beer-Lambert law states that:

$$A = \epsilon l c$$

A is the absorbance

ϵ is the molar absorption coefficient ($l \text{ mol}^{-1} \text{ cm}^{-1}$)

C is the concentration (mol l^{-1})

l is the path length (cm)

This law shows that absorbance is linear to concentration but this is only true for low concentrations. For absorbance levels above 3 the concentration starts to move away from the linear relationship.

Transmittance is the proportion of the light which passes through the sample:

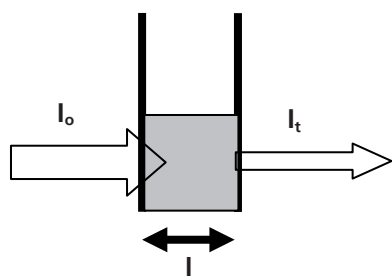

Where:

I_o is the incident light

I_t is the transmitted light

l is the path length

Therefore: $T = I_t/I_o$

Absorbance is inversely related to transmittance:

$$A = -\log T = -\log(I_t/I_o)$$

فروشگاه تجهیزات آزمایشگاهی روناکو

3.2 SPECTROSCOPY MEASUREMENT

There are four main components of a spectrophotometer. These are a light source to emit a high and constant amount of energy over the full wavelength range, a sample holder, a method for separating the light into discrete wavelengths and a light detector.

The optical layout of the 7200 spectrophotometer is shown below. The 7205 optical layout is similar but there is no LED.

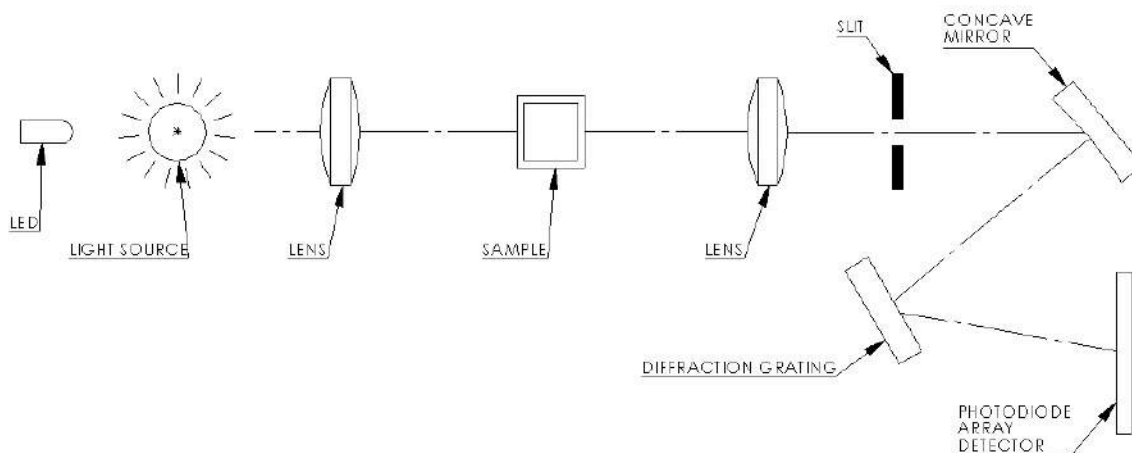

Figure 3.2.1 – Diagram of light path

The whole light spectrum from the pre-aligned tungsten halogen lamp and the LED (7200) or xenon lamp (7205) is collimated through a lens and passed through the sample. The spectrum of light then passes through a further slit and lens arrangement before being focussed onto the diffraction grating, which separates the light into discrete wavelengths. The light which has not been absorbed by the sample is measured by the photodiode array detector. The photo-diode array detector used is mounted directly onto the detector PCB and the output is used to calculate the % transmittance. The result is displayed either as % transmittance or absorbance on the instrument display.

3.3 GOOD PRACTICE GUIDELINES

1. For optimum performance all spectrophotometers should be sited in a clean, dry, dust free atmosphere. When in use ambient temperature and light levels should remain as constant as possible.
2. If required adherence to Standard Operating Procedures (SOP) and Good Laboratory Practice (GLP) should be monitored with regular calibration checks and a suitable Quality Control (QC) programme.
3. Ensure that there is nothing additional in the sample chamber which could block the light path during calibration and sample measurement. Do not divert the light path using a mirrored surface within the sample compartment.
4. The correct selection of sample containers is imperative for accurate and reproducible results:
 - a) Check that the material of the sample container is compatible with the wavelengths to be used for measurement. In general glass can only be used down to 360nm or 320nm depending on quality. Standard plastic cuvettes can be used down to 320nm. Special UV versions can be used down to 260nm. Below this level quartz cuvettes must be used.
 - b) Plastic disposable cuvettes should only be used ONCE.

- c) Glass cuvettes should be thoroughly cleaned after use. Discard when scratches become evident on optical surfaces.
 - d) Care should be taken when selecting semi-micro or micro cuvettes. The cuvette window on the inner chamber (the area filled with sample) must be wider than the aperture in the sample holder or light will reach the detector without passing through the sample. In this case, semi-micro or micro cuvettes with self-screening black surrounds must be used or, alternative holders for these cuvettes should be used.
 - e) Glass test tubes and other sample tubes should be used with care. Where possible, matched tubes should be used and any index mark set to the correct position before measurements are made.
 - f) Ensure any sample containers used are compatible with the constituents of both the samples and standards they are to hold. Plastic cuvettes are not compatible with organic solvents.
 - g) All sample containers must be handled with care; by the top, bottom and non-optical surfaces only. Any finger marks evident must be removed by a suitable cleaning process.
 - h) Flow-through cuvettes must be selected with care and consideration for the sample type, sample volume, pumping system, rinse, sample and waste handling to be used.
5. Samples and standards should not be stored in open cuvettes or sample containers as evaporation will change the value and lead to staining of the walls which may be irreversible. If stored in stoppered and sealed cuvettes, they should be filled with little or no air space and the values regularly checked against a reference standard or quality control material.
 6. Samples should be allowed to equilibrate to ambient temperature before measurement (unless a suitable temperature controlled sample holder is in use). Temperature change during measurement may cause air bubbles to form on the walls of the sample holder. This is a common cause of drift during measurement.
 7. In the preparation of samples and standards high grade borosilicate glass and AR grade chemicals and reagents must be used. Good quality deionised water or other suitable solvents must be used for dissolving or diluting samples, chemicals and reagents.
 8. All measurements require calibration to a blank, for maximum accuracy this should be prepared with care using the same deionised water or solvent used for dissolving or diluting the sample. Where reagents are added to the sample to produce a colour proportional to its concentration a 'sample based' blank should be used. In this case the blank should consist of all reagents or chemicals to be used, except the sample which will produce the colour to be measured.
 9. Deviations from the Beer-Lambert Law may occur at high and low concentrations giving non-linear response during sample concentration measurements. For all new methods a linear range should be defined by the preparation of a calibration curve. The quantitation mode may be used to construct such a curve against which sample results are automatically measured.
 10. Cuvettes and sample holders must be filled to a minimum level which covers the light path. All Jenway spectrophotometers have a beam height of 15mm.
 11. The instrument must be calibrated to zero absorbance/100% transmittance prior to taking readings. In the spectrum measurement mode a baseline scan must be performed before performing a sample scan.

SECTION 4 – Instrument Setup

4.1 NAVIGATING AND SCREEN SETUP



The main home screen is displayed below:

	Single wavelength
	Spectrum
	Kinetics

The spectrophotometer has a colour touchscreen user interface. To navigate around the spectrophotometer screen, touch the icon or text which you want to action.

In every screen there is a **back arrow** which returns to the previous screen without saving any changes.





In each measurement mode there is a **home** icon which returns immediately to the home screen.





	Simple (Abs/%T)
	Optical Density
	Use A Factor
	Use Standard(s)

4.2 INSTRUMENT SETTINGS SCREEN

The instrument settings screen is accessed by touching the **instrument settings** icon in the Home Screen. This screen enables access to printing and saving options, heated cell accessory control, setting date and time, language and software updates. Touch the **down arrow** to view the second screen.

فروشگاه تجهیزات آزمایشگاهی روناسی

	Printing and Saving
	Heated Cell
	Date and Time
	Language English

	Updated Software
	
	
	

4.3 PRINTING AND SAVING



Printing (with the accessory printer) and saving (to a USB memory stick) can be performed manually in each mode but for selected measurement modes it can also be set up to be carried out automatically. Automatic saving can only be done in the single measurement modes.





Touch **Printing** or **Saving** to toggle between Manual and Automatic.

	Printing Manual
	Saving Manual

	Printing Automatic
	Saving Manual

To print or save manually in any measurement mode, touch the **overflow** icon button at the bottom of the screen.

	0.146 ^{Abs}		
	71.4 ^{%T}		
	500 ^{nm}		
	Blank	Read	...

	0.146 ^{Abs}		
	71.4 ^{%T}		
	500 ^{nm}		
			...

Touching the **overflow** icon displays the options for manual printing or manual saving. Touch the **save** icon to save the result to USB memory stick. If a USB memory stick is not inserted an error message will be displayed. Touch the **print** icon to print the results using an external printer. If the printer is not connected, switched on or out of paper an error message will be displayed. Touching the **overflow** icon once again will cycle the screen back to the previous view, allowing blank and sample measurements to be performed.

Once a sample reading has been performed if the results are not saved to USB memory stick a warning message will be displayed when the mode is exited by pressing the **Home** icon.

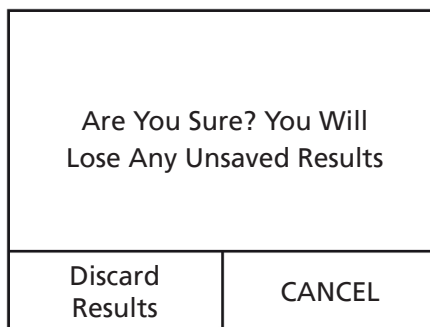

Touch **Discard Results** to exit the measurement mode and the results will not be saved. Touch **CANCEL** to return to the measurement mode so that the results can be saved.

4.4 HEATED CELL ACCESSORY CONTROL

A heated 10x10mm cuvette holder is available as an optional accessory for the spectrophotometer. This accessory enables the temperature of the sample to be adjusted. To set up the parameters of the heated cell accessory, touch **Heated Cell** in the Settings screen. **Note:** Heated Cell will only be active if the accessory is fitted. Touch **Use Heated Cell** to toggle between Off and On.

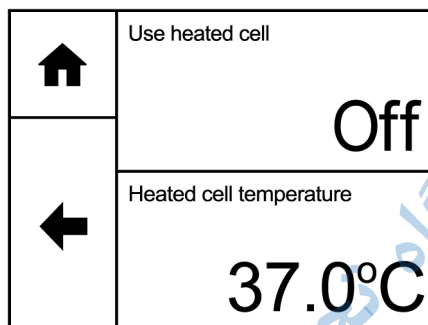
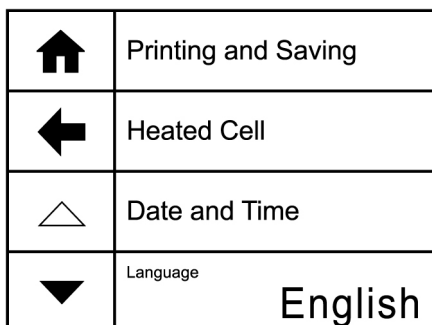

To adjust the temperature of the heated cell, touch **Heated Cell Temperature**. Touch the **up** or **down** arrows to increase or decrease the set temperature in 0.5°C increments. The minimum temperature is 32°C, the maximum temperature is 42°C. Touch **OK** to confirm or touch the **back arrow** to return to the previous screen without saving any changes. Please note that the heated cell takes approximately 30 mins to heat a 2.5ml sample to 37°C.

فروشگاه اینترنتی آریما پیشگامی روناسی

🏠	▲
←	37.0°C
OK	▼

🏠	Use heated cell
	On
←	Heated cell temperature
	37.5°C

4.5 DATE AND TIME

The time and date screen enables the current time and date to be set. This information will be saved on all results and displayed on printouts.

🏠	Date	04/05/2016
	Time	17:07
←	Date Format	DD/MM/YYYY
	Time Format	24-hour clock

🏠	▲ ▲ ▲
←	04/05/16
OK	▼ ▼ ▼

To adjust the date touch **Date** and use the **arrow** icons to increase or decrease the number. Touch **OK** to confirm or touch the **back arrow** to return to the previous screen without saving any changes.

🏠	▲	▲
←	17	: 08
OK	▼	▼

To adjust the time touch **Time** and use the arrow icons to increase or decrease the number. Touch **OK** to confirm or touch the **back arrow** to return to the previous screen without saving any changes.

فروشگاه تجهیزات آزمایشگاهی روناسی

The date format can be displayed as either European format dd/mm/yyyy or American format mm/dd/yyyy by touching **Date Format**. To display the time as either a 12 hour clock or a 24 clock touch **Time Format**.

🏠	Date 04/05/2016
	Time 05:09 PM
←	Date Format DD/MM/YYYY
	Time Format 12-hour clock

🏠	Date 05/04/2016
	Time 17:08
←	Date Format MM/DD/YYYY
	Time Format 24-hour clock

4.6 LANGUAGE

🏠	Impression et sauvegarde
←	Support thermostaté
△	Date et heure
▼	Langue Français

The spectrophotometer operating software can also be displayed in French or German. To select the required language touch **Language**. Touch **English**, **Français** or **Deutsche** depending on the language required. The language selected will also be displayed on the printouts. The selected language when the instrument is switched off will be loaded when the instrument is turned on.

4.7 SOFTWARE UPDATE

🏠	Update Software
←	
▲	
▼	



The spectrophotometer operating software can be updated via USB memory stick. The update must first be downloaded to a USB memory stick from the Jenway website. Insert a USB device into the USB port on the front of the instrument and navigate to the Update Software option in the settings screen. Touch **Update Software** to begin the update.

🏠	Current Version 0.6.3 / 00.01 (01/07/16)
←	Version on USB No USB stick found
	Load Software

If there is no USB memory stick inserted the above screen will be shown.

🏠	Current Version 0.6.3 / 00.01 (01/07/16)
←	Version on USB No update found stick
	Load Software

If there is no update file on the USB memory stick the above screen will be shown.

	<p>Current Version 0.6.3 / 01.00 (01/07/16)</p>
	<p>Version on USB 0.6.3 / 01.01 (07/07/16)</p>
<p>Load Software</p>	

If there is a valid update file on the USB memory stick, then **Load Software** becomes active.

Touch **Load Software** to start the upload process.

<p>Push update to begin installing new software.</p>	
<p>Update</p>	<p>Cancel</p>

Touch **Update** to begin installing the new software.

<p>Copying Update 4%</p>	

At the end of the update, the instrument will restart and the bootloader will perform the update.

<p>Your instrument has been update to Version 1.01</p>
<p>Continue</p>



Once the update is completed touch **Continue** to complete the update process.

فروشگاه تجهیزات آزمایشگاهی رونکو

SECTION 5 – Single Wavelength

The single wavelength measurement mode provides options to measure simple absorbance and % transmittance, optical density and concentration using a factor, single standard or quantitation curve. Touch **Simple Wavelength** to display the different measurement modes:

	Single wavelength
	Spectrum
	Kinetics

 	Simple (Abs/%T)
	Optical Density
	Use A Factor
	Use Standard(s)

Simple (Abs/%T)

This option allows simple measurements of absorbance or % transmittance to be performed.

Optical Density

Optical density measurement mode enables optical density measurements of cell cultures and broths to be performed. In this mode, it is possible to use a known factor to estimate the number of cells present.

Use A Factor

This measurement mode enables concentration measurements to be performed. It is possible to use a known factor to determine the concentration of a solution based on the measured absorbance.

Use Standard(s)

This mode enables sample concentrations to be calculated using a standard curve or a single standard. In this mode, a number of standard solutions covering a range of known concentrations are measured at a set wavelength. The absorbance or % transmittance of these solutions are plotted to create a standard curve with replicate standard measurements, if required. Once the standard curve has been created, a sample of unknown concentration can be measured and the concentration calculated using the standard curve. If only one standard is available the instrument will subsequently calculate the factor which can be used to calculate the unknown concentration.

فروشگاه تخصصی آزمون پزشکی
از ما بپوشگاهی روناسی

5.1 SIMPLE (ABS/%T) MEASUREMENT MODE

↑	Wavelength (nm)
←	500
→	Measurement name
	SAMPLE

Simple (Abs/%T) enables simple measurements of absorbance and % transmittance to be performed. The sample is measured at every wavelength but only the result for the selected wavelength is displayed. There are no post measurement calculations available in this measurement mode. Touch **Simple (Abs/%T)** to enter this measurement mode and begin method setup.

5.1.1 Method Setup

↑	Wavelength (nm)
←	500
→	Measurement name
	SAMPLE

The method parameters which can be selected are the wavelength and the measurement name. Once these have been entered (see below) touch the **forwards arrow** to enter the measurement screen. The **back arrow** will return to the previous screen and the **home** icon will return to the home screen. Neither of these options will save any parameters entered.

5.1.2 Selecting a Wavelength

Touch **Wavelength (nm)** to enter the required wavelength. Either type the wavelength required using the numeric keypad or touch **delete** to clear the screen and then type in the wavelength. Touch **OK** to confirm and save or touch the **back arrow** to return to the previous screen without saving the entered wavelength.

↑	500 ^{nm}			
←	1	2	3	⊗
OK	4	5	6	.
	7	8	9	0

فروشگاه تجهیزات آزمایشگاهی روناکو

5.1.3 Measurement Name

Touch **Measurement Name** to enter the required name for the sample. This name will be used to identify the result on any printouts or if the result is saved to USB memory stick. Either type the name required using the alphanumeric keypad or touch **delete** to clear the screen and then type in the name.

Please note the name is restricted to a maximum of 8 characters. Touch **OK** to confirm and save or touch the **back arrow** to return to the previous screen without saving the entered name. The **ABC** icon will toggle between alpha and numeric options.

↑	SAMPLE			
	1	2	3	⊗
←	4	5	6	ABC
	7	8	9	0
OK				

5.1.4 BLANK CALIBRATION AND SAMPLE MEASUREMENT

↑	-.-.- Abs		
←	-.- %T		
	500 nm		
	Blank	Read	○○○

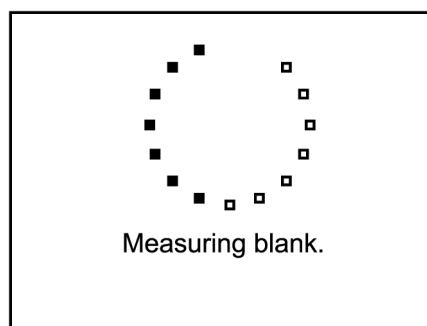

A blank calibration must be performed before a sample can be measured. Insert a cuvette containing the blank solution into the sample chamber. Touch **Blank** and the instrument will perform a zero absorbance and 100% transmittance reading.

↑	0.000 Abs		
←	100.0 %T		
	500 nm		
	Blank	Read	○○○

Once the blank calibration is complete **Read** becomes active and the sample can be measured. As the spectrophotometer measures the entire wavelength range in one scan, if the wavelength is adjusted before a sample is measured the instrument doesn't need be calibrated again at the new wavelength.

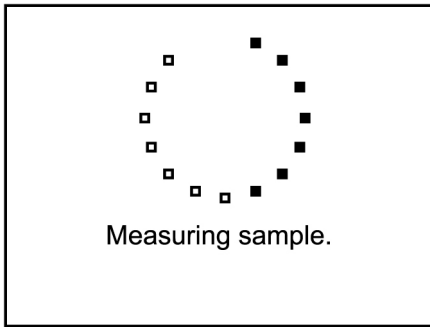

🏠	0.146 _{Abs}	
	71.4 _{%T}	
←	500 _{nm}	
	Blank	Read ...

Remove the cuvette containing the blank solution and place a cuvette containing the sample to be measured in the sample holder. Touch **Read** to measure the sample. Once the measurement is complete the photometric result will be shown on the screen. Subsequent samples can be measured in the same way.

To adjust the wavelength there is no need to return to the method setup. Touch the screen to open the adjustment screen. Touch the **arrow** icons to increase or decrease the wavelength. The photometrics result will be adjusted accordingly. Touch the **back arrow** to return to the measurement screen and the adjusted results will be displayed on the screen.

	▲	505 _{nm}
←		
	▼	0.127 _{Abs}
		74.7 _{%T}

🏠	0.127 _{Abs}	
	74.7 _{%T}	
←	505 _{nm}	
	Blank	Read ...

5.2 OPTICAL DENSITY MEASUREMENT MODE

The OD 600 measurement mode enables optical density measurements of cell cultures and broths to be performed. In this measurement mode it is possible to use a known factor to estimate the number of cells. There are no post measurement calculations available in this measurement mode. Touch **Optical Density** to enter this measurement mode and begin method setup.

5.2.1 Method Setup

🏠	Wavelength (nm)	600
←	Measurement name	OD600
	Factor	1.000
→	Units	cells/ml

The method parameters which can be selected are the wavelength, the measurement name, the factor and the concentration units. Once these have been entered touch the **forwards arrow** to enter the measurement screen. The **back arrow** will return to the previous screen and the **home** icon will return to the home screen. Neither of these options will save any parameters entered.

5.2.2 Selecting a Wavelength

Touch **Wavelength** (nm) to enter the required wavelength. Either type the wavelength required using the numeric keypad or touch **delete** to clear the screen and then type in the wavelength. Touch **OK** to confirm and save or touch the **back arrow** to return to the previous screen without saving the entered wavelength.

↑	600 nm			
	1	2	3	⊗
←	4	5	6	.
	7	8	9	0
OK				

5.2.3 Measurement Name

Touch **Measurement Name** to enter the required name for the sample. This name will be used to identify the result on any printouts or if the result is saved to USB memory stick. Either type the name required using the alphanumeric keypad or touch **delete** to clear the screen and then type in the name.

Please note the name is restricted to a maximum of 8 characters. Touch **OK** to confirm and save or touch the **back arrow** to return to the previous screen without saving the entered name. The **ABC** icon will toggle between alpha and numeric options.

↑	OD600			
	ABC	DEF	GHI	⊗
←	JKL	MNO	PQR	123
	OK	STU	VWX	YZ
				⌂

5.2.4 Entering a factor

↑	+/-	1.000		
	1	2	3	⊗
←	4	5	6	.
	OK	7	8	9
				0

Touch **Factor** to enter the required factor. The minimum factor which can be entered is -1000, the maximum factor which can be entered is +1000. Either type the factor required using the numeric keypad or touch **delete** to clear the screen and then type in the factor. Touch **OK** to confirm and save or touch the **back arrow** to return to the previous screen without saving the entered factor.

5.2.5 Entering concentration units

🏠	cells/ml			
	abc	def	ghi	⌫
←	jkl	mno	pqr	123
	OK	stuv	wxyz	μ% /

The standard units of measure for optical density is cells/ml but these can be adjusted depending on requirements. Touch **Units** to adjust the concentration units. Please note that this is just a text field and changing within a unit family e.g. mg/l and g/l will not change the concentration result.

Either type the units required using the alphanumeric keypad or touch **delete** to clear the screen and then type in the units. Please note the units are restricted to a maximum of 8 characters. Touch **OK** to confirm and save or touch the **back arrow** to return to the previous screen without saving the entered units. The **123** icon will toggle between alpha and numeric options.

5.2.6 BLANK CALIBRATION AND SAMPLE MEASUREMENT

🏠	- . - - - cells/ml		
	- . - - - Abs		
←	- . - %T		
	600 nm		
	Blank	Read	ooo

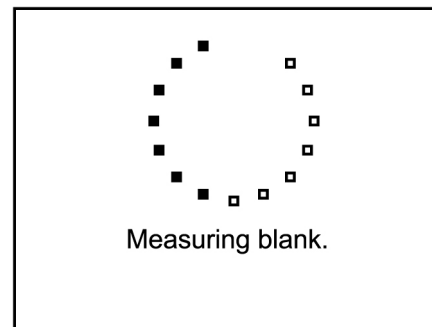

A blank calibration must be performed before a sample can be measured. Insert a cuvette containing the blank solution into the sample chamber. Touch **Blank** and the instrument will perform a zero absorbance and 100% transmittance reading.

🏠	0.000 cells/ml		
	0.000 Abs		
←	100.0 %T		
	600 nm		
	Blank	Read	ooo

Once the blank calibration is complete **Read** becomes active and the sample can be measured. As the spectrophotometer measures the entire wavelength range in one scan, if the wavelength is adjusted before a sample is measured the instrument doesn't need to be calibrated again at the new wavelength.

فروشگاه تجهیزات آزمایشگاهی و نانو

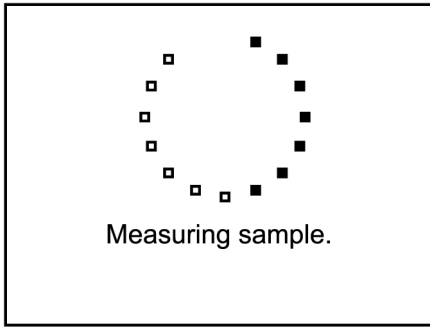

🏠	0.379 _{cells/ml}	
←	0.379 _{Abs}	
	41.8 _{%T}	
	600 _{nm}	
	Blank	Read ...

Remove the cuvette containing the blank solution and place a cuvette containing the sample to be measured in the sample holder. Touch **Read** to measure the sample. Once the measurement is complete the result will be shown on the screen. Subsequent samples can be measured in the same way.

To adjust the wavelength there is no need to return to the method setup. Touch the screen to open the adjustment screen. Touch the **arrow** icons to increase or decrease the wavelength. The result will be adjusted accordingly. Touch the **back arrow** to return to the measurement screen and the adjusted results will be displayed on the screen.

	▲	505 _{nm}
←		0.127 _{Abs}
	▼	74.7 _{%T}

🏠	0.379 _{cells/ml}	
←	0.379 _{Abs}	
	41.8 _{%T}	
	600 _{nm}	
	Blank	Read ...

5.3 USE A FACTOR MEASUREMENT MODE

The Use A Factor measurement mode enables concentration measurements to be performed. In this measurement mode it is possible to use a known factor to determine the concentration of a solution based on the measured absorbance:

$$\text{Concentration} = \text{Factor} \times \text{Absorbance}$$

If the factor isn't known then the Use Standard(s) measurement mode must be used to calculate concentration. Touch **Use A Factor** to enter this measurement mode and begin method setup.

🏠	Simple (Abs/%T)
←	Optical Density
	Use A Factor
	Use Standard(s)

5.3.1 Method Setup

↑	Wavelength (nm) 500
←	Measurement name SAMPLE
→	Factor 0.000
→	Units mg/l

The method parameters which can be selected are the wavelength, the measurement name, the factor and the concentration units. Once these have been entered touch the **forwards arrow** to enter the measurement screen. The **back arrow** will return to the previous screen and the **home** icon will return to the home screen. Neither of these options will save any parameters entered.

5.3.2 Selecting a Wavelength

Touch **Wavelength (nm)** to enter the required wavelength. Either type the wavelength required using the numeric keypad or touch **delete** to clear the screen and then type in the wavelength. Touch **OK** to confirm and save or touch the **back arrow** to return to the previous screen without saving the entered wavelength.

↑	500 nm			
←	1	2	3	⊗
OK	4	5	6	.
OK	7	8	9	0

5.3.3 Measurement Name

Touch **Measurement Name** to enter the required name for the sample. This name will be used to identify the result on any printouts or if the result is saved to USB memory stick. Either type the name required using the alphanumeric keypad or touch **delete** to clear the screen and then type in the name. Please note the name is restricted to a maximum of 8 characters. Touch **OK** to confirm and save or touch the **back arrow** to return to the previous screen without saving the entered name. The **ABC** icon will toggle between alpha and numeric options.

↑	SAMPLE			
←	ABC	DEF	GHI	⊗
OK	JKL	MNO	PQR	123
OK	STU	VWX	YZ	⎵

5.3.4 Entering a factor

🏠	+/-	1.000		
←	1	2	3	⊗
OK	4	5	6	.
	7	8	9	0

Touch **Factor** to enter the required factor. The minimum factor which can be entered is -1000, the maximum factor which can be entered is +1000. Either type the factor required using the numeric keypad or touch **delete** to clear the screen and then type in the factor. Touch **OK** to confirm and save or touch the **back arrow** to return to the previous screen without saving the entered factor.

5.3.5 Units of measure

🏠	mg/l			
←	abc	def	ghi	⊗
OK	jkl	mno	pqr	123
	stuv	wxyz	μ%	/

Touch **Units** to adjust the concentration units. Please note that this is just a text field and changing within a unit family e.g. mg/l and g/l will not change the concentration result.

Either type the units required using the alphanumeric keypad or touch **delete** to clear the screen and then type in the units. Please note the units are restricted to a maximum of 8 characters. Touch **OK** to confirm and save or touch the **back arrow** to return to the previous screen without saving the entered units. The **123** icon will toggle between alpha and numeric options.

5.3.6 BLANK CALIBRATION AND SAMPLE MEASUREMENT

🏠	-.--- mg/l		
←	-.--- Abs		
	-.-%T		
	500 nm		
	Blank	Read	ooo

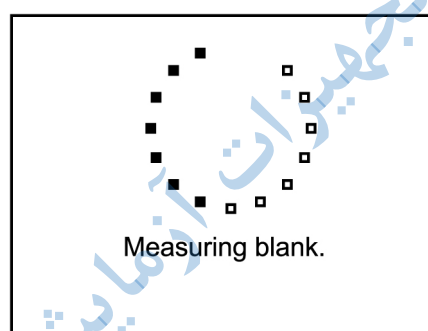

A blank calibration must be performed before a sample can be measured. Insert a cuvette containing the blank solution into the sample chamber. Touch **Blank** and the instrument will perform a zero absorbance and 100% transmittance reading.

↑	0.000 %	
←	0.000 Abs	
	100.0 %T	
	500 nm	
	Blank	Read
		...

Once the blank calibration is complete **Read** becomes active and the sample can be measured. As the spectrophotometer measures the entire wavelength range in one scan, if the wavelength is adjusted before a sample is measured the instrument doesn't need be calibrated again at the new wavelength.

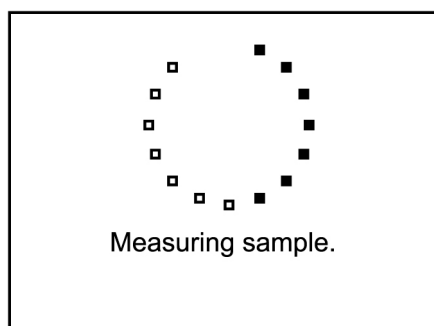

↑	0.676 mg/l	
←	0.676 Abs	
	21.1 %T	
	500 nm	
	Blank	Read
		...

Remove the cuvette containing the blank solution and place a cuvette containing the sample to be measured in the sample holder. Touch **Read** to measure the sample. Once the measurement is complete the result will be shown on the screen. Subsequent samples can be measured in the same way.

To adjust the wavelength there is no need to return to the method setup. Touch the screen to open the adjustment screen. Touch the **arrow** icons to increase or decrease the wavelength. The result will be adjusted accordingly. Touching the **back arrow** to return to the measurement screen and the adjusted results will be displayed on the screen.

	▲	505 nm
←		0.127 Abs
	▼	74.7 %T

↑	0.127 Abs	
←	74.7 %T	
	505 nm	
	Blank	Read
		...

5.4 USE STANDARD(S) MEASUREMENT MODE

The Use Standard(s) measurement mode enables sample concentration to be calculated using a standard curve or a single standard of known concentration. In this mode a number of standard solutions covering a range of known concentrations are measured at a set wavelength. The absorbance or % transmittance of these solutions is plotted to create a standard curve with replicate standards measurements, if required. Once the standard curve has been created a sample of unknown concentration can be measured and the concentration calculated using the standard curve.

If there is only one standard available this measurement mode will calculate the factor and use that to calculate the concentration.

Touch **Use Standard(s)** to enter this measurement mode and begin method setup.

🏠	Simple (Abs/%T)
←	Optical Density
←	Use A Factor
←	Use Standard(s)

5.4.1 Method Setup

The method parameters enable the creation of a standard curve or a previously created standard curve can be opened to measure unknown samples against.

🏠	Load A Standard Curve
←	Wavelength (nm) 500
→	Measurement name SAMPLE

🏠	Units mg/l
←	Standards 2
→	Replicates 1

The method parameters which can be adjusted are the wavelength, the measurement name, the units of measure, the number of known standards and the number of replicates. Once these have been entered touch the **forwards arrow** to enter the measurement screen. The **back arrow** will return to the previous screen and the **home** icon will return to the home screen. Neither of these options will save any parameters entered.

5.4.2 Selecting a Wavelength

Touch **Wavelength (nm)** to enter the required wavelength. Either type the wavelength required using the numeric keypad or touch **delete** to clear the screen and then type in the wavelength. Touch **OK** to confirm and save or touch the **back arrow** to return to the previous screen without saving the entered wavelength.

🏠	500 ^{nm}			
←	1	2	3	⊗
OK	4	5	6	.
	7	8	9	0

5.4.3 Measurement Name

Touch **Measurement Name** to enter the required name for the sample. This name will be used to identify the result on any printouts or if the result is saved to USB memory stick. Either type the name required using the alphanumeric keypad or touch **delete** to clear the screen and then type in the name.

Please note the name is restricted to a maximum of 8 characters. Touch **OK** to confirm and save or touch the **back arrow** to return to the previous screen without saving the entered name. The **ABC** icon will toggle between alpha and numeric options.

🏠	SAMPLE			
←	1	2	3	⊗
OK	4	5	6	ABC
	7	8	9	0

5.4.4 Entering Concentration Units

🏠	mg/l			
←	abc	def	ghi	⊗
OK	jkl	mno	pqr	123
	stuv	wxyz	μ%	/

Touch the **forwards arrow** to display the additional parameters. Touch **Units** to adjust the concentration units. Please note that this is just a text field and changing within a unit family e.g. mg/l and g/l will not change the concentration result.

Either type the units required using the alphanumeric keypad or touch **delete** to clear the screen and then type in the units. Please note the units are restricted to a maximum of 8 characters. Touch **OK** to confirm and save or touch the **back arrow** to return to the previous screen without saving the entered units. The **123** icon will toggle between alpha and numeric options.

5.4.5 Selecting the Number of Standards and Replicates

The number of standards used can be changed between 1 and 6. If 1 is selected then a calibration curve will not be created. Touch the number of standards required and touch the **back arrow** to return to method setup.

	1	2
←	3	4
	5	6

Each standard can have up to 3 replicate measurements performed. If more than 1 replicate is selected the instrument will take the average absorbance value of the replicates measured to construct the calibration curve. Touch the number required and touch the **back arrow** to return to method setup.

←	1
	2
	3

5.4.6 Measuring Standards

←	Press to perform blank
→	

Before the concentration of each known standard can be measured a blank calibration must be performed. Insert the cuvette containing the blank solution and touch **Press to perform blank**.

🏠	Set Standard 1 (mg/l)
←	Read Replicate 1
→	

The concentration of each known standard must be entered before it is measured. Touch **Set Standard 1** and use the number entry screen to enter the concentration of the standard. Touch **OK** to confirm and save or press the **back arrow** to return to the measure standards screen without saving the concentration.

↑	Standard 1
	10.000
←	Replicate 1
→	0.835Abs

Insert the cuvette containing standard 1 and touch **Replicate 1**. The instrument will perform a reading and display the absorbance result. If more than one replicate has been selected, touch **Replicate 2** to perform the second reading. Repeat if necessary for 3 replicates. Touch the **forwards arrow** to measure the next standard.

↑	Standard (mg/l)
	15.000
←	Absorbance
	0.339
→	Factor
	44.288

If only 1 standard has been selected then the factor will be displayed. This factor can be used to calculate the concentration of the unknown sample.

↑	Standard 2
	20.000
←	Replicate 1
→	1.740Abs

If more than 1 standard has been selected each additional standard must be measured in the same way. Touch **Set Standard 2** and use the number entry screen to enter the concentration of the standard. Touch **OK** to confirm and save or press the **back arrow** to return to the measure standards screen without saving the concentration. Insert the cuvette containing standard 2 and touch **Replicate 1**.

The instrument will perform a reading and display the absorbance result. Touch the **forwards arrow** to measure the next standard or display the calibration curve if only 2 standards have been selected.

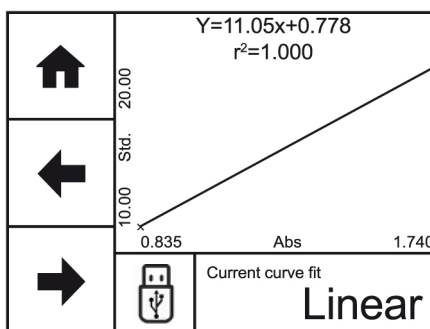

Once all the standards have been measured the calibration curve will be displayed. Touch **Current Curve Fit** to toggle between linear or linear through zero.

Linear: $Concentration = Abs \times A + B$

Linear through zero: $Concentration = Abs \times A$

Where: gradient of the line (A), constant (B) and correlation coefficient (r^2).

Touch **save** to save the standard curve to USB memory stick. If there isn't a USB memory stick inserted a warning will be displayed.

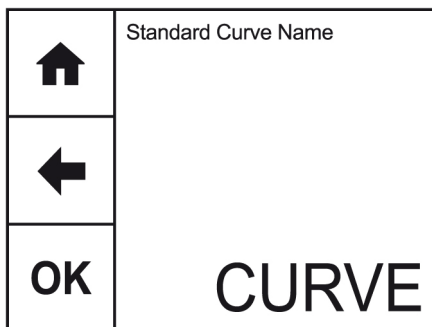

Touch **Standard Curve Name** to enter the required name for the curve. This name will be used to identify the curve on the USB memory stick. Either type the name required using the alphanumeric keypad or touch **delete** to clear the screen and then type in the name. Please note the name is restricted to a maximum of 8 characters. Touch **OK** to confirm and remember the entered name or touch the **back arrow** to return to the previous screen without remembering the entered name. The **ABC** icon will toggle between alpha and numeric options.

Touch **OK** to confirm and save or touch the **back arrow** to return to the previous screen without saving the entered name. If the curve has been saved the instrument will display confirmation.

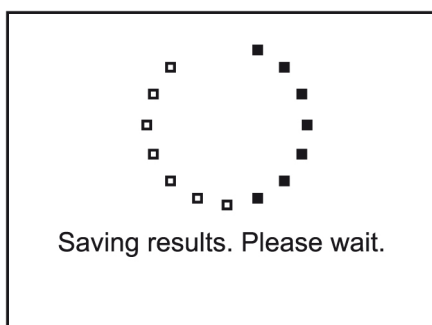

Touch the **forwards arrow** to enter the measurement screen.

5.4.7 Load Standard Curve

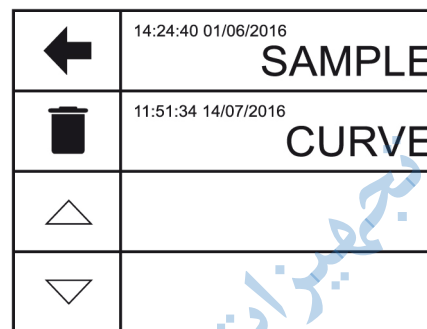
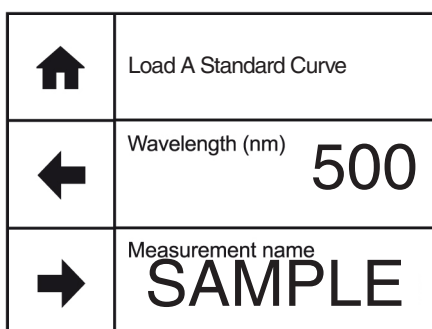

It is not necessary to create a new standard curve each time an unknown sample needs to be measured. Ensure the USB memory stick is inserted into the instrument. Touch **Load A Standard Curve** and a list of previously saved standard curves will be displayed. Touch the **up** or **down** arrows to display more results on the screen. The files are saved in date and time order from most recent to oldest. Touch the name of the required curve and the standard curve will automatically be loaded. To return to the previous screen without loading a standard curve touch the **back arrow**.

	14:24:40 01/06/2016 SAMPLE
	11:51:34 14/07/2016 CURVE

	14:24:40 01/06/2016 SAMPLE ✓
	11:51:34 14/07/2016 CURVE
OK	

To delete a standard curve from the USB memory stick touch **delete**. Touch the name(s) of the curve to be deleted. To deselect a curve touch the name of the curve again. Touch **OK** to confirm or touch the **back arrow** to return to the previous screen without loading or deleting any standard curves.



If there are no standard curves saved to the USB memory stick an error message will be displayed.

Touch the **forwards arrow** to enter the measurement screen.

5.5 BLANK CALIBRATION AND SAMPLE MEASUREMENT

	-.--- mg/l		
	-.--- Abs		
	-.-%T		
	500 nm		
	Blank	Read	ooo

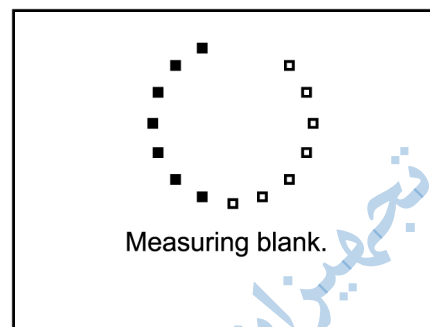

A blank calibration must be performed before a sample can be measured. Insert a cuvette containing the blank solution into the sample chamber. Touch **Blank** and the instrument will perform a zero absorbance and 100% transmittance reading.

	0.000 %		
	0.000 Abs		
	100.0 %T		
	500 nm		
	Blank	Read	...

Once the blank calibration is complete **Read** becomes active and the sample can be measured.

Remove the cuvette containing the blank solution and place a cuvette containing the sample to be measured in the sample holder. Touch **Read** to measure the sample. Once the measurement is complete the result will be shown on the screen. Subsequent samples can be measured in the same way.

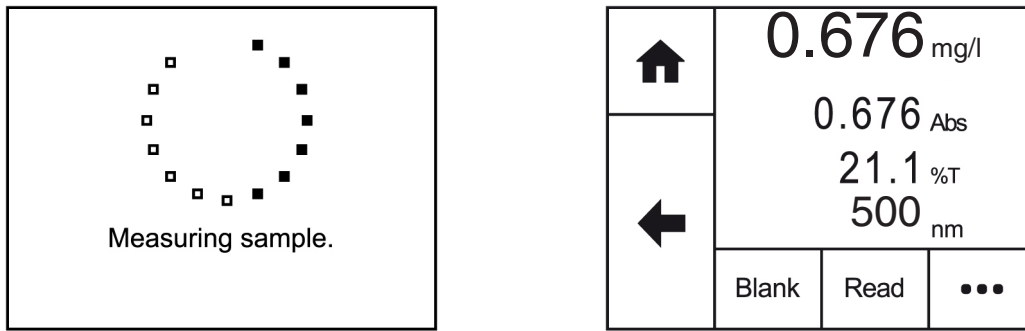

Although this spectrophotometer measures the entire wavelength range in one scan if the wavelength needs to be adjusted a new calibration curve must be created at the new wavelength.



فروشگاه تجهیزات آزمایشگاهی رونکو

SECTION 6 – Spectrum

The spectrum measurement mode enables measurements of absorbance or % transmittance over a range of wavelengths to be performed. The absorbance or % transmittance at each wavelength is plotted graphically. Post measurement tools such as spectral points analysis can be performed. This operating mode can be used to partially characterise a sample. Touch **Spectrum** to enter this measurement mode and begin method setup.

	Single wavelength
	Spectrum
	Kinetics





6.1 METHOD SETUP

	Measurement name SAMPLE
	Measure Mode Absorbance
	Start Wavelength 400
	End Wavelength 500

The method parameters which can be selected are, the measurement name, the measurement mode and the start and end wavelengths. Once these have been entered touch the **forwards arrow** to enter the measurement screen. The **back arrow** will return to the previous screen and the **home** icon will return to the home screen. Neither of these options will save any parameters entered.

6.1.1 Measurement Name

Touch **Measurement Name** to enter the required name for the sample. This name will be used to identify the result on any printouts or if the result is saved to USB memory stick. Either type the name required using the alphanumeric keypad or touch **delete** to clear the screen and then type in the name. Please note the name is restricted to a maximum of 8 characters. Touch **OK** to confirm and save or touch the **back arrow** to return to the previous screen without saving the entered name. The **ABC** icon will toggle between alpha and numeric options.

	SAMPLE			
	1	2	3	
	4	5	6	ABC
	7	8	9	0

6.1.2 Selecting Measurement Mode

The measurement mode can be user selected between absorbance and % transmittance. Touch **Measurement Mode** to cycle between the two options.

6.1.3 Setting Start and End Wavelengths

This function enables the start and end wavelengths of the spectrum scan to be set. The 7200 has a spectrum range from 335 to 800nm and measures the entire wavelength range simultaneously. The 7205 has a spectrum range from 198 to 800nm. However the user can select the wavelength range which is displayed. Following the measurement the start and end wavelengths can be adjusted and the spectrum across the new wavelength range will be displayed.

↑	400 nm			
←	1	2	3	⌫
OK	4	5	6	.
	7	8	9	0

Touch **Start Wavelength** or **End Wavelength** to enter the required wavelength. Either type the wavelength required using the numeric keypad or touch **delete** to clear the screen and then type in the wavelength. Touch **OK** to confirm and save or touch the **back arrow** to return to the previous screen without saving the entered wavelength. The start wavelength must be smaller than the end wavelength.



Wavelength(s) cannot be the same

Once the required wavelengths have been entered touch the **forwards arrow** to move into the measurement screen. If the start and end wavelengths entered are equal, the instrument will display a short warning before returning back to the parameters screen to allow further editing.

Start wavelength (600nm) is above end wavelength (500nm)

Swap Values	Go Back
-------------	---------

If the start wavelength is above the end wavelength a warning will be displayed.

Touch **Swap Values** to simply swap the start and end wavelengths and continue. Touch **Go Back** to edit the start and end wavelengths.

Once all the parameters have been entered touch the **forward arrow** to enter the measurement screen.

فروشگاه تجهیزات آزمایشگاهی روناکو

6.2 BLANK CALIBRATION AND SAMPLE MEASUREMENT

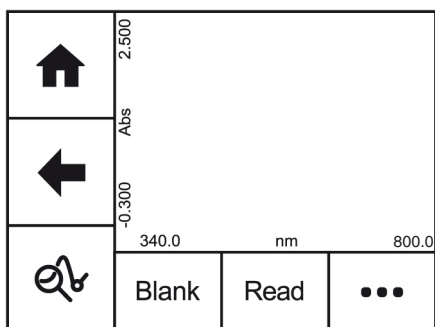

A blank calibration must be performed before a sample can be measured. Insert a cuvette containing the blank solution into the sample chamber. Touch **Blank** and the instrument will perform a baseline calibration.

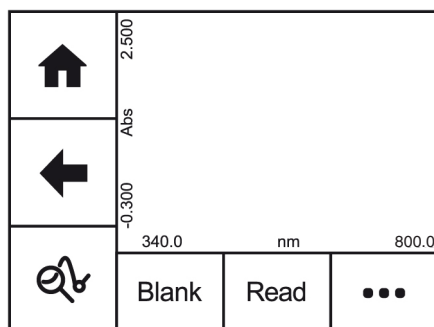
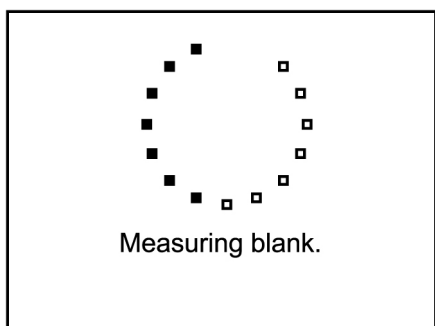

Once the baseline has been completed **Read** becomes active and the sample can be measured. Remove the blank cuvette containing the blank solution and place a cuvette containing the sample to be measured into the sample holder. Touch **Read** to measure the sample.

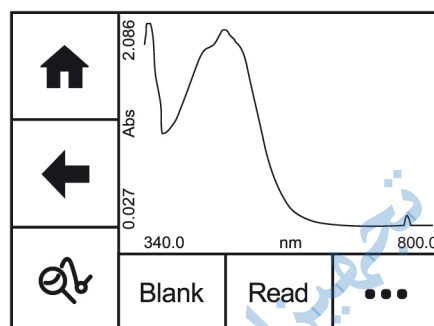
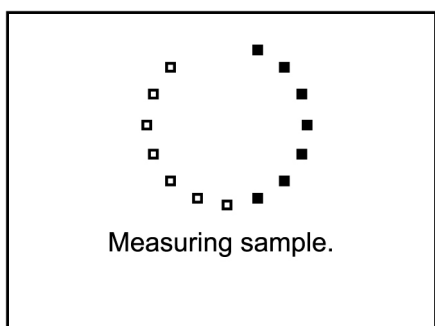

As the entire wavelength range is measured simultaneously it is not possible to view a live spectrum scan as the wavelengths are not measured one at a time. Once the measurement is complete the spectrum scan will be displayed on the screen and the post measurement tools icon will become active.

6.3 DATA ANALYSIS

Once a measurement has been completed the post measurement tools icon becomes active. Touch the **post measurement tool** icon to open tools screen. This enables access to the zoom function and the spectral points analysis function.

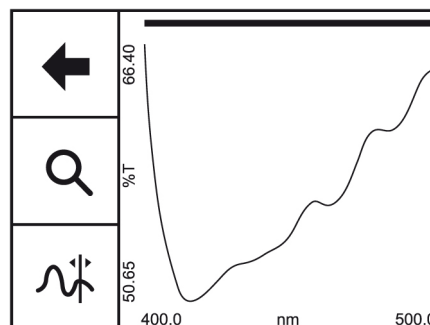
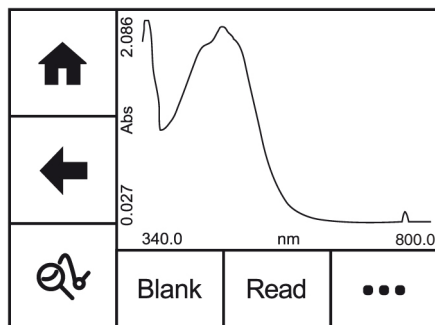

The zoom function enables areas of interest on the spectrum to be magnified. The spectral points analysis function enables points to be selected from the scan to analyse absorbance or % transmittance at selected wavelengths.

6.3.1 Spectrum Zoom

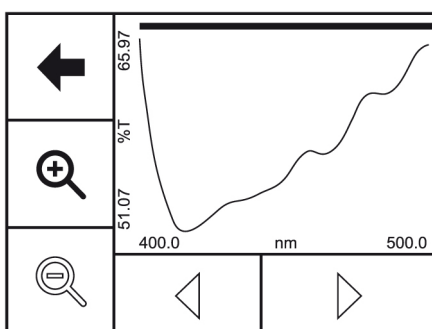

Touch the **zoom** icon to open the zoom screen. When the spectrum zoom mode is first entered, only **Zoom In** is enabled. **Zoom Out, Zoom Left** and **Zoom Right** are only available once the display is showing a zoomed in part of the scan rather than a full scan. To zoom in on a particular section of the scan, either touch the scan on the required part or touch **Zoom In** to zoom in centrally on the displayed portion of the scan.

The zoom bar at the top of the screen indicates both how far the scan is zoomed in and over which portion of the original scan the zoomed in portion is from – this is indicated by a green bar.

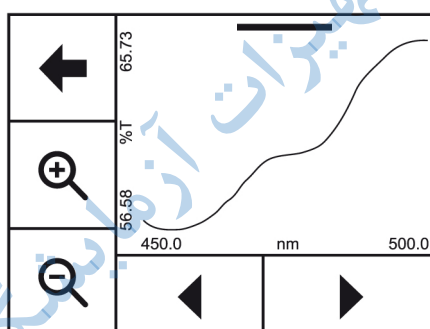
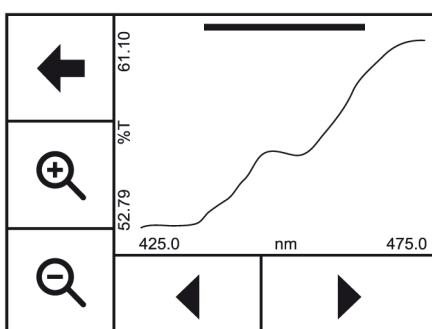

Touch the **Zoom In** icon to increase magnification or touch the **Zoom Left** or **Zoom Right** arrows to move the magnification to a different part of the spectrum. Touch **Zoom Out** to return to the original spectrum scan.

Touch the **back arrow** to return to the previous screen.

6.3.2 Spectral Points Analysis

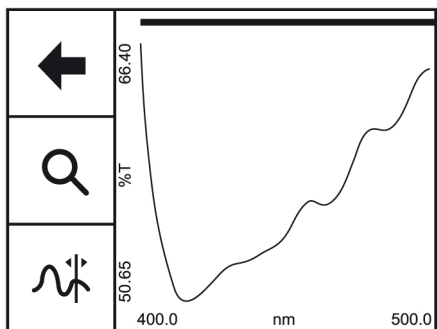

The spectral points analysis function enables points to be selected from the scan to analyse the absorbance or % transmittance at a selected wavelength. Touch **spectral points analysis** to open the selection screen.

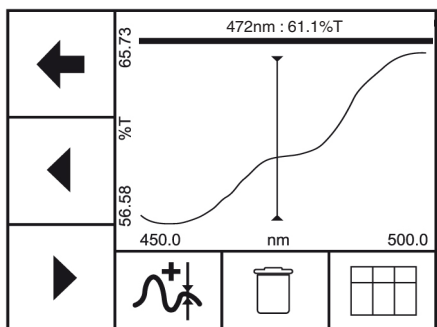

A solid vertical line will appear on the screen. The position of the line can be moved by touching the **arrow** icons or by touching the screen. The values at the top of the screen display the wavelength and photometrics result for that point. When the required point is selected touch **add to table** icon and the selected point will be added to the table. Once the point has been added it will be marked on the spectrum. Up to 50 points can be added to the table.

To delete all the points from the spectral points analysis table touch **delete**.

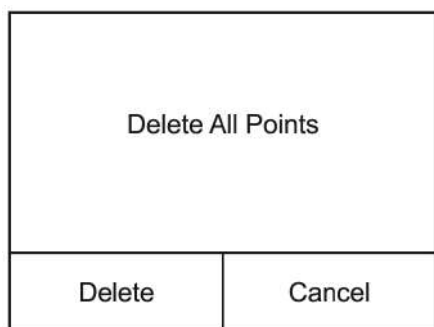





Touch **Delete** to delete all previously selected points or touch **Cancel** to return to the spectral points analysis screen.

←	nm	%T
...	461	58.1
△	472	61.0
▽	490	63.6

To view the points in the spectral points analysis table touch the **table** icon. The selected points will be displayed along with the absorbance or % transmittance depending on the measurement mode selected in the method setup. The results will be displayed in numerical order from smallest to largest.

To view points not displayed on the screen touch the **up** or **down arrows**.

Touch the **Overflow** icon to select printing or saving options:

	nm	%T
	461	58.1
	472	61.0
	490	63.6

Touch **Print** to print the spectral analysis points table. An error message will be displayed if an external printer is not connected or switched on.



Touch the **save** icon to save the spectral points analysis to a USB memory stick. If no USB memory stick is inserted, an error message will be displayed.



To exit spectral points analysis touch the **backwards** arrow. If the points haven't been saved to USB memory stick a warning message will be displayed:

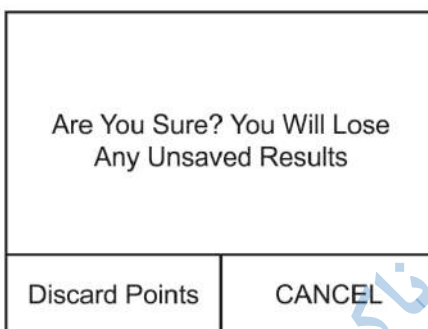



Touch **Discard Points** to delete the previously selected points or press **CANCEL** to return to the spectral points analysis.

SECTION 7 – Kinetics

The kinetics measurement mode enables the change in absorbance or % transmittance of an active molecule to be measured over a period of time. For example, enzyme analysis of horseradish peroxidase. The absorbance or % transmittance is measured at regular time intervals at a set wavelength over a period of time. The results are plotted on a graph to show the change in absorbance or % transmittance over time. The final absorbance reading can also be used to calculate concentration. Touch **Kinetics** to enter this measurement mode and begin method setup.

	Single wavelength
	Spectrum
	Kinetics

There are two options available when using the kinetics measurement mode:



	Calculate Rate Of Change From Absorbance
	Include An Endpoint Factor And Concentration





1. To calculate the rate of change of absorbance or % transmittance over time – this option doesn't include a concentration result.

2. To calculate the rate of change of absorbance or % transmittance over time but also calculate a concentration result based on the endpoint absorbance value. This option requires a factor value to be entered in method setup.

7.1 METHOD SETUP

Rate of Change Only

	Measurement name SAMPLE
	Number of wavelengths 3
	Measurement Mode Absorbance

	Run Time (Seconds) 150
	Read Interval (Seconds) 10
	Lag Time (Seconds) 0
	Wavelength (nm) 400

The parameters which can be selected are the measurement name, the number of wavelengths, the measurement mode, run time, read interval, lag time and wavelength. Once these have been entered touch the **forwards arrow** to enter the measurement screen. The **back arrow** will return to the previous screen and the **home** icon will return to the home screen. Neither of these options will save any parameters entered.

Rate of Change and Concentration

↑	Measurement name SAMPLE
←	Number of wavelengths 3
→	Measurement Mode Transmittance

↑	Run Time (Seconds) 150
←	Read Interval (Seconds) 10
→	Lag Time (Seconds) 0
→	Units mg/l

↑	Wavelength 1 400
←	Endpoint factor
→	1.000

The parameters which can be selected are the measurement name, the number of wavelengths, the measurement mode, run time, read interval, lag time, concentration units, wavelength and end point factor. Once these have been entered touch the **forwards arrow** to enter the measurement screen. The **back arrow** will return to the previous screen and the **home** icon will return to the home screen. Neither of these options will save any parameters entered.

7.1.1 Measurement Name

Touch **Measurement Name** to enter the required name for the sample. This name will be used to identify the result on any printouts or if the result is saved to USB memory stick. Either type the name required using the alphanumeric keypad or touch **delete** to clear the screen and then type in the name. Please note the name is restricted to a maximum of 8 characters. Touch **OK** to confirm and save or touch the **back arrow** to return to the previous screen without saving the entered name. The **ABC** icon will toggle between alpha and numeric options.

↑	SAMPLE			
←	ABC	DEF	GHI	⊗
OK	JKL	MNO	PQR	123
	STU	VWX	YZ	┌

7.1.2 Selecting Number of Wavelengths

↑	Measurement name SAMPLE	1
←	Number of wavelengths 3	2
→	Measurement Mode Absorbance	3

Touch **Number of Wavelengths** to select the required number of wavelengths. Touch **1**, **2** or **3** to select the required number of wavelengths to measure the change in absorbance or % transmittance over time.

7.1.3 Selecting Measurement Mode

The measurement mode can be user selected between absorbance and % transmittance. Touch **Measurement Mode** to cycle between the two options.

7.1.4 Run Time

Touch **Run Time (Seconds)** to enter the total run time for the kinetics experiment. Either type the time required using the numeric keypad or touch **delete** to clear the screen and then type in the time. Touch **OK** to confirm and save or touch the **back arrow** to return to the previous screen without saving the entered time. The minimum run time is 15 seconds (model 7200) or 7 seconds (model 7205), the maximum run time is 9999 seconds. Due to the size of the instrument memory the instrument can only store 100 measurement points per wavelength. Depending on the run time entered the instrument will calculate the minimum measurement interval, subject to a minimum interval of 15 or 7 seconds depending on the model.

↑	Run Time (Seconds) 150	↑	60 Seconds			
←	Read Interval (Seconds) 10	←	1	2	3	⊗
→	Lag Time (Seconds) 0	OK	4	5	6	.
	Units mg/l		7	8	9	0

7.1.5 Read Interval

Touch **Read Interval (Seconds)** to enter the time interval between each measurement taken over the whole kinetics experiment. Either type the time in seconds required using the numeric keypad or touch **delete** to clear the screen and then type in the time. Touch **OK** to confirm and save or touch the **back arrow** to return to the previous screen without saving the entered time. The minimum time between readings is 15 seconds (model 7200) or 7 seconds (model 7205). Due to the size of the instrument memory the instrument can only store 100 measurement points per wavelength. As a default the instrument will calculate the minimum measurement interval based on the total run time, subject to a minimum interval of 7 or 15 seconds, depending on the model.

↑	Run Time (Seconds)	150
←	Read Interval (Seconds)	10
→	Lag Time (Seconds)	0
→	Wavelength (nm)	400

↑	20 ^{Seconds}			
←	1	2	3	⊗
OK	4	5	6	.
OK	7	8	9	0

7.1.6 Lag time (Seconds)

Touch **Lag Time (Seconds)** to enter the time interval that the instrument waits before commencing measurements after **Start** has been touched in the measurement screen. Either type the time required using the numeric keypad or touch **delete** to clear the screen and then type in the time. Touch **OK** to confirm and save or touch the **back arrow** to return to the previous screen without saving the entered time. The minimum lag time is 0 seconds, the maximum lag time is 999 seconds.

7.1.7 Selecting Concentration Units

In the option to include the concentration result, the units of concentration can be entered. The concentration is calculated using the end point absorbance value:

$$\text{Concentration} = \text{Factor} \times \text{end point absorbance}$$

↑	Run Time (Seconds)	150
←	Read Interval (Seconds)	10
→	Lag Time (Seconds)	0
→	Units	mg/l

↑	mg/l			
←	abc	def	ghi	⊗
OK	jkl	mno	pqr	123
OK	stuv	wxyz	μ%	/

Touch **Units** to enter the required concentration units. Either type the units required using the alphanumeric keypad or touch **delete** to clear the screen and then type in the units. Note the units are restricted to a maximum of 11 characters. Touch **OK** to confirm and save or touch the **back arrow** to return to the previous screen without saving the entered units. The **123** icon will toggle between alpha and numeric options.

7.1.8 Selecting a Wavelength and Factor

The wavelength and factor for each wavelength selected will need to be entered.

↑	Wavelength 1	500
←	Endpoint factor	1.000
→		

↑	500 ^{nm}			
←	1	2	3	⊗
OK	4	5	6	.
OK	7	8	9	0

Touch **Wavelength 1** to enter the required wavelength. Either type the wavelength required using the numeric keypad or touch **delete** to clear the screen and then type in the wavelength. Touch **OK** to confirm and save or touch the **back arrow** to return to the previous screen without saving the entered wavelength.

At the end of the kinetics run the concentration of the sample can be calculated using the end point absorbance value:

$$\text{Concentration} = \text{Factor} \times \text{end point absorbance}$$

Touch **Endpoint Factor** to enter the required factor to calculate the concentration. Either type the factor required using the numeric keypad or touch **delete** to clear the screen and then type in the factor. Touch **OK** to confirm and save or touch the **back arrow** to return to the previous screen without saving the entered factor. If you do not require the concentration to be calculated leave the factor as a default of 1. The minimum factor which can be entered is -1000, the maximum factor which can be entered is +1000.

↑	+/-	1.000		
←	1	2	3	⊗
	4	5	6	.
OK	7	8	9	0

7.2 BLANK CALIBRATION AND SAMPLE MEASUREMENT

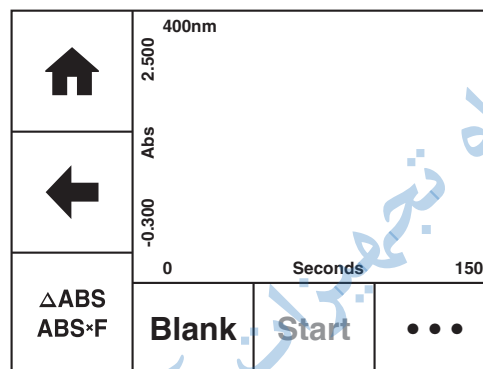
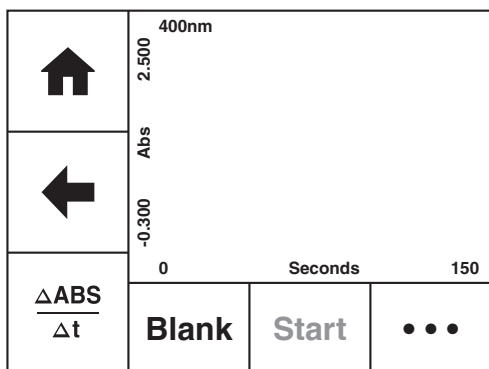

A blank calibration must be performed before a sample can be measured. Insert a cuvette containing the blank solution into the sample chamber. Touch **Blank** and the instrument will perform a zero absorbance and 100% transmittance reading.

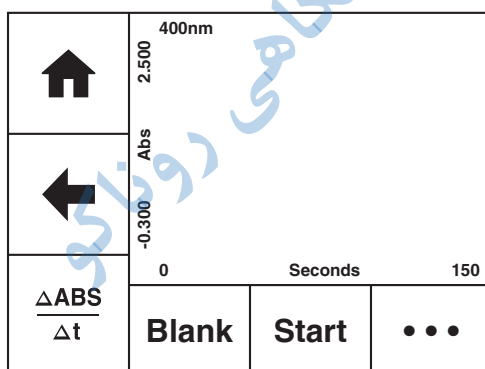

Once the blank calibration is complete **Start** becomes active and the sample can be measured. As the spectrophotometer measures the entire wavelength range in one scan, if the selected wavelength(s) are adjusted before a sample is measured the instrument doesn't need be calibrated again at the new wavelength(s).

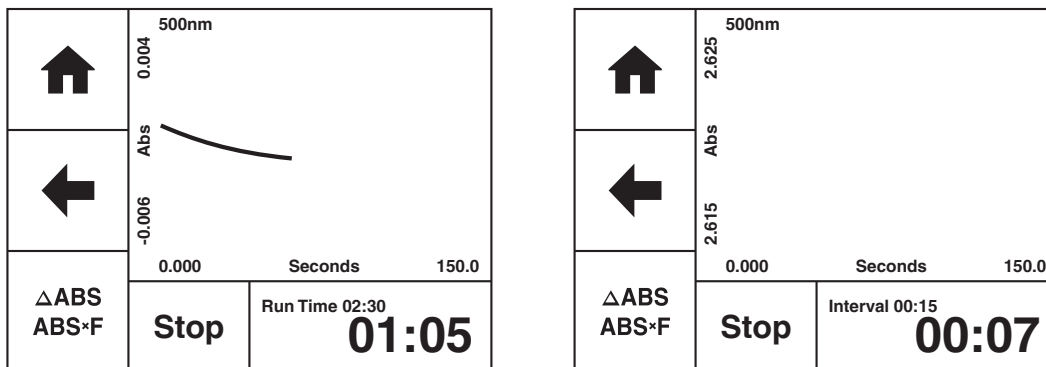

Remove the cuvette containing the blank solution and place a cuvette containing the sample to be measured in the sample holder. Touch **Start** to measure the sample.

During the kinetics run the full run time in minutes will be displayed in the bottom right hand corner of the measurement screen. Touch **Run Time** to toggle the display between showing the total elapsed time of the kinetics run or showing the measurement interval count down to the next measurement being taken.

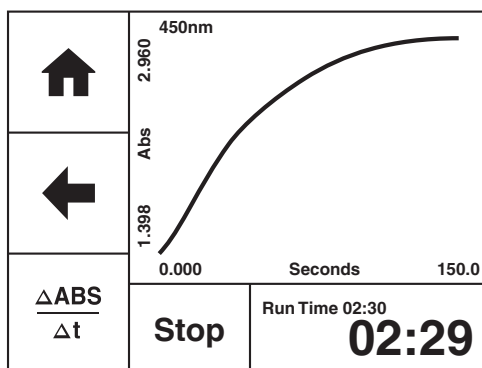

When the instrument is not taking a measurement the kinetics run can be stopped by touching **Stop**. Whilst a measurement is being taken, **Stop** is temporarily inactive to touches.

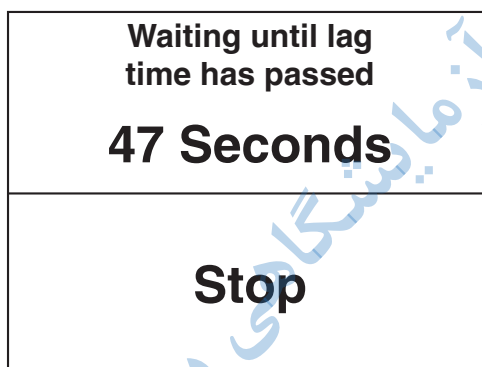

If a lag time was entered during method set up the instrument will count down the lag time before it begins taking measurements. To stop the lag time count down touch **Stop**.

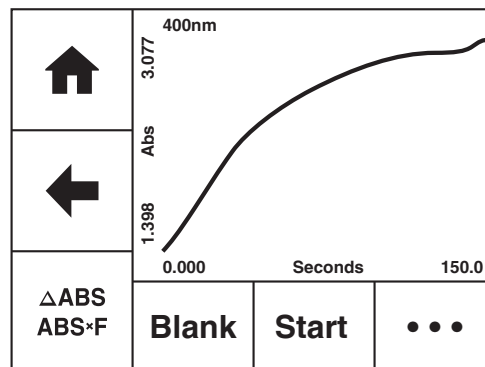
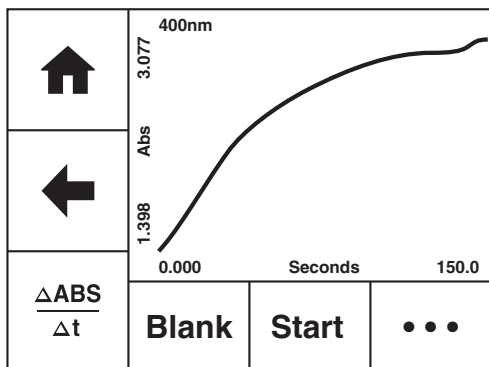

Once the measurement is complete the **Post Measurement** icon becomes active. Subsequent samples can be measured in the same way.

7.3 Post Measurement Analysis

Rate of Change Only

Once the kinetics run is complete it is possible to view the rate of change for each selected wavelength. Touch the **Post Measurement** icon to display the information. Touch the **wavelength** to move through the selected wavelengths or touch the **back arrow** to return to the measurement screen. The information displayed includes the absorbance readings at the start Abs (t=0) and end Abs (t=n) of the kinetics run, as well as the rate of change, Abs/Min.













↑	400 nm		
	0.138 Abs ^(t=0)		
←	0.007 Abs ^(t=n)		
	-0.052 Abs/Min		
	400nm	450nm	500nm

Rate of Change and Concentration









Once the kinetics run is complete it is possible to view the endpoint concentration and rate of change for each selected wavelength. Touch the **Post Measurement** icon to display the information. Touch the **wavelength** to move through the selected wavelengths or touch the **back arrow** to return to the measurement screen. The information displayed includes the absorbance readings at the end of the kinetics run, the end point factor and the concentration.

↑	400 nm		
	0.040 mg/l		
←	0.008 Abs ^(t=n)		
	-0.052 Abs/Min		
	400nm	450nm	500nm

SECTION 8 – Glossary of Icons

Icon	Description
	Back Arrow – return to previous screen
	Forwards Arrow – move to next screen
	Home – returns to home screen
	Instrument Settings – access to instrument settings
	Print – to send results to an external printer
	Save – to save results to a USB memory stick
	Overflow – to toggle display between Blank/Read and Save /Print
	Up Arrow - to move up or increase
	Down Arrow - to move down or decrease
OK	OK - to confirm
	Delete – to delete entry
	Space – used when naming results or standard curves
ABC	ABC – toggles between alpha and numeric keypads
123	123 – toggles between alpha and numeric keypads
	Standard curve selected for deletion
	Post measurement analysis tool for spectrum

فروشگاه تجهیزات ازوبیستگاهوی رونکو

Icon	Description
	Spectral zoom
	Zoom In
	Zoom Out
	Zoom to the right (spectrum)
	Zoom to the left (spectrum)
	Spectral points analysis
	Add Spectral point to table
	Delete all spectral analysis points or delete selected standard curves
	Table – view selected spectral analysis points
$\frac{\Delta \text{ABS}}{\Delta t}$	Post measurement analysis tool for kinetics - Rate of change only
$\frac{\Delta \text{ABS}}{\text{ABS} \times F}$	Post measurement analysis tool for kinetics - Rate of change and concentration
$\text{Abs}^{(t=0)}$	Absorbance at the start of the kinetics run
$\text{Abs}^{(t=n)}$	Absorbance at the end of the kinetics run

فروشگاه تجهیزات آزمایشگاهی روناسو

SECTION 9 – Accessories and Spare Parts

9.1 OPTIONAL ACCESSORIES

Part Code	Description of Accessory
SMP50/PRINTER	External printer
630 204	10 x 10mm path length cuvette holder
637 071	16/24mm test tube holder
630 005	10 to 100mm path length cuvette holder
630 304	Micro-cuvette holder with reduced aperture
019 148	4GB USB memory sticks for external memory
060 084	Pack of 100 disposable cuvettes (visible)
060 230	Pack of 100 disposable cuvettes (visible and UV)
700 000	Dust Cover

9.2 CONNECTING THE ACCESSORIES

There are two types of accessories which can be fitted in the sample chamber – passive (nonpowered) or active (powered) accessories. The range of passive accessories includes 10 x 10mm single cuvette holder, adjustable path length (10 to 100 mm) cuvette holder, test tube holder and micro-cuvette holder. The range of active accessories includes a heated cell. The instrument must be turned off before any accessories are fitted. There is also an external printer available for instant result print outs.

9.2.1 External Printer



The external printer can be connected via the USB cable to the USB port on rear of the instrument. To turn the printer on press and hold the power button until the green lights stop flashing. If the printer isn't detected when **Print** is touched or automatic printing is set up, an error icon will be shown. This error message will also be shown if the printer fails to print due to no paper.

Please follow the instructions provided in the SMP50/PRINTER user manual for replacing the paper and fitting and charging the printer batteries.

9.2.2 Passive Accessories

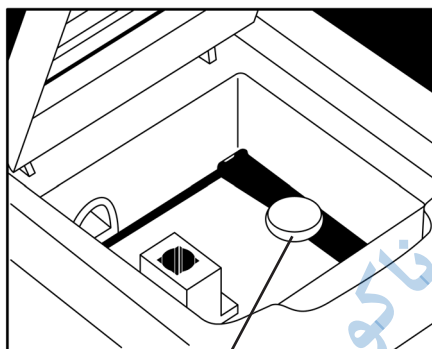

Thumb screw

Unscrew the thumb screw to undo the passive accessory. Lift out the passive accessory. To fit a different passive accessory simply place the accessory in the correct orientation, align the thumb screw and tighten to fix in place.

To replace the passive accessory with an active accessory refer to section 9.2.3.

Please note that if the adjustable path length cuvette holder is fitted and a cuvette with a path length greater than 1cm is used, the results need to be manually adjusted according to the Beer-Lambert law which states that:

$$A = \epsilon l c$$

A is the absorbance

ϵ is the molar absorption coefficient ($l \text{ mol}^{-1} \text{ cm}^{-1}$)

C is the concentration (mol l^{-1})

l is the path length (cm)

This correction will also need to be applied if test tubes are used. The path length is the internal diameter of the test tube.

9.2.3 Active Accessories

Important Notice

The heated cell holder is supplied with a more powerful power supply unit to provide the additional power required by the heated cell accessory. When installing a heated cell holder, the original power supply unit supplied with the instrument **must be disconnected and replaced with the power supply unit supplied with the heated cell accessory.**

- Power supply unit supplied with instrument: 12vDC, 3.8A
- Power supply unit with heated cell: 12vDC, 5A

Failure to use the appropriate power supply unit when using the heated cell may cause damage to the power supply unit which will not be covered by the manufacturer's warranty.

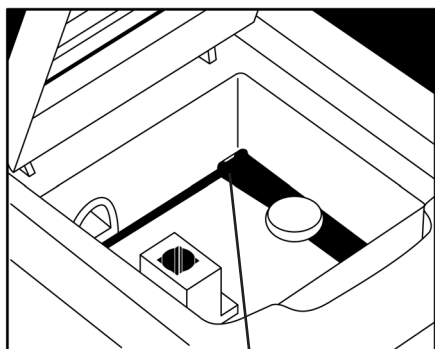

Socket for heated cell accessory

Ensure the instrument is switched off, disconnected from the mains power and the power supply has been changed over as described above. Remove the passive accessory as described in Section 9.2.2. Place the heated cell accessory into the sample chamber. Connect the plug to the socket in the back right hand side of the chamber. The plug and socket will lock together as the locking tag on the top of the plug 'clicks' into place.

For instructions on how to operate the heated cell accessory refer to section 4.4.

To remove the heated cell accessory ensure that the instrument is switched off and unplugged from the mains power. Unscrew the thumb screw and disconnect the accessory power lead by holding down the top clip on the connector and pulling the connector backwards.

If the heated cell accessory is removed it is not necessary to change the power supply unit back to the less powerful power supply unit originally supplied with the spectrophotometer.

9.3 SPARES

The spare parts for the 7200 and 7205 spectrophotometers are listed below:

Part Code	Description
012 050	Tungsten Halogen lamp module (7200 only)
630 204	10x10mm path length cuvette holder
M7980	12V 3.8A power supply unit for spectrophotometer
607 167	12V 5A power supply unit for the heated cell accessory
M7817UK	UK Power lead
M7817X6	EU Power lead
US7817X1	US Power lead
037 702	Paper roll for printer

SECTION 10 – Maintenance and Service

10.1 ROUTINE MAINTENANCE AND CLEANING

Ensure the external surfaces of the unit are clean and free from dust. The sample area should always be kept clean and any accidental spillage should be wiped away immediately. To give added protection when not in use, the unit should be disconnected from the mains supply and covered with the optional dust cover.

In the event of accidental spillage on or within the instruments measurement compartment, immediately switch off the equipment and disconnect from the mains supply. Dry the unit with a cloth and leave to dry for an appropriate period before commencing use.

If the instrument needs to be cleaned ensure the equipment is switched off and disconnected from the mains supply before cleaning. Wipe down the unit with a soft damp cloth and a mild detergent solution. Do not use bleach or abrasives. Do not allow cleaning liquids to ingress inside the equipment. Never immerse the unit, cables or plugs in water or any other liquids. Allow any wet surfaces to dry before re-connecting to the mains supply and commencing use.

Servicing should only be carried out by qualified personnel.

Service personnel should be aware that the lamp, its holder and surrounding enclosure will be extremely hot (above 200°C) during use and for a period of time after use. Before starting any maintenance or service, switch the instrument OFF, remove from the mains supply and allow to cool for at least 20 minutes. Wear protective gloves to prevent injury when replacing the lamp or working within the vicinity of the lamp.

Do not work within the instrument while the lamp is ON as exposure to the high intensity light can cause injury to your eyes.

10.2 LAMP REPLACEMENT (7200 only)

10.2.1 Halogen Lamp Module Replacement

Before replacing the lamp disconnect the unit from the mains supply and ensure the lamp is cool before handling. The instrument should be switched off for at least 20 minutes. Wear 'lint free' protective gloves when replacing the lamp to avoid injury from burns and to prevent marking the lamp with finger prints.

Access to the tungsten halogen lamp can be gained via the lamp access panel located on the underside of the instrument (refer to section 2.5).

1. Remove the screws holding the lamp access panel in place.
2. Remove the lamp cover.
3. Remove the two fixing screws and washers which retain the lamp assembly (Fig 1).
4. Detach the electrical connector (Fig 2).
5. Grab the two tabs on the plastic lamp assembly and remove the whole lamp assembly, this may need to be rotated slightly to allow it to be removed (Fig 3).
6. Carefully remove the replacement lamp from the packaging and remove the protective cover from the lamp assembly (Fig 4). Ensure that the glass portion of the lamp is not touched as finger marks will damage the lamp resulting in a reduced performance. If accidental damage occurs the surface of the lamp may be cleaned using propan-2-ol.

7. Insert the new lamp assembly into the same position as the one just removed. This may need to be rotated slightly to be fully inserted. Ensure that the fixing holes in the plastic lamp assembly line up with the fixing holes in the unit. If the holes do not line up then the lamp assembly must be rotated 180 degrees. The lamp assembly must be pulled back out to do this.
8. Fix the two screws and washers removed earlier back in position to fully secure the lamp assembly. It must be fully pulled against the black aluminium fixing plate.
9. Re-couple the electrical connector.
10. Replace the lamp cover ensuring no wires are trapped and fix in position with the two screws.
11. Place the unit back in its correct orientation and ensure there are no samples or cuvettes in the holder and that the 10x10 cuvette holder is fitted.
12. Reconnect the power supply, turn the unit on and allow time for the unit to self-calibrate with the new lamp.

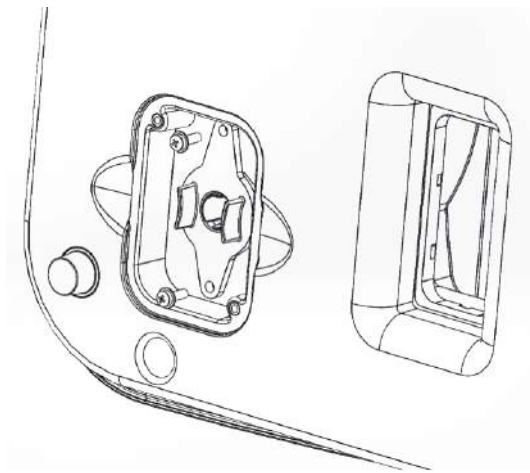

Fig. 1

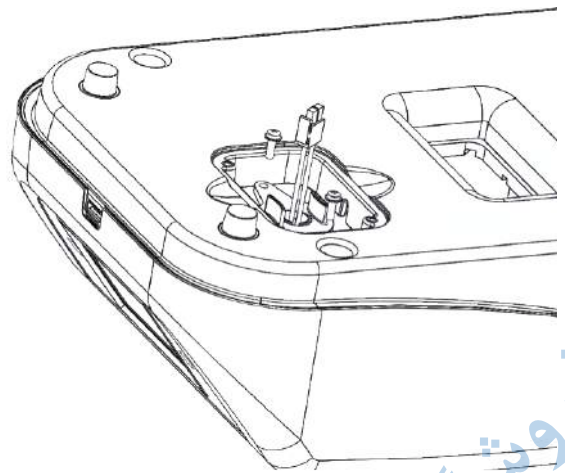

Fig. 2

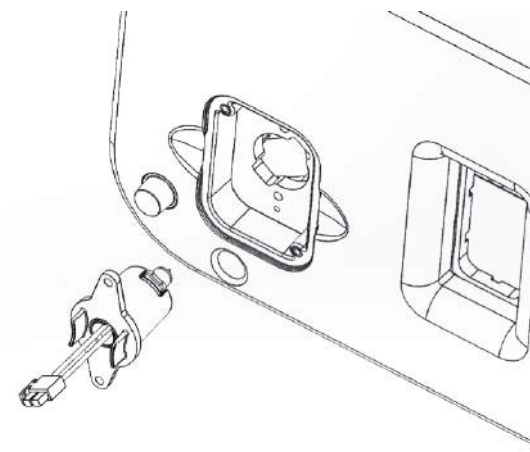

Fig. 3

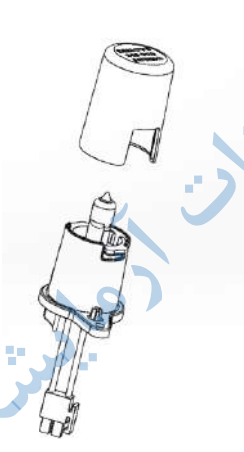

Fig. 4

فروشگاه تجهیزات آروینگتون

روناک

10.3 FIRMWARE UPDATE PROCEDURE

The 7200 and 7205 spectrophotometers allow users to update the instrument's firmware using a USB flash drive using the following procedure:

1. Download the latest version of the instrument's firmware from the Jenway website at www.jenway.com/Software.asp and copy the file to a USB flash drive.
2. Switch on the power to the instrument.
3. Insert the USB flash drive into the USB memory stick slot of the instrument.
4. Refer to section 4.7 to complete the update procedure.

10.4 SERVICE

Our dedicated service team are on hand to help in the unlikely event that your Jenway equipment develops a fault. Please contact them by one of the following means with a clear description of the problem:

E-mail: cpSERVICE@coleparmer.com

Tel: +44 (0) 1785 810475

On occasion it may be necessary for your equipment to be sent back to our Service Department for repair. In this case please contact the Service Department for a reference number which you should include with your faulty equipment. Please also ensure you include a clear description of the fault and a completed copy of our Decontamination Certificate. This is available as a downloadable pdf file at www.jenway.com, or contact us and we will be happy to email or fax you a copy. Please clearly mark the package for the attention of the Service Department and post to the following address:

Cole-Parmer Ltd
Beacon Road
Stone
Staffordshire
ST15 0SA
United Kingdom

All replacement parts are guaranteed for 1 year and where ever possible, returned equipment is turned around in 10 working days.

10.5 WARRANTY

Cole-Parmer Ltd. warrants this instrument to be free from defects in material and workmanship, when used under normal laboratory conditions, for a period of 2 years. This includes the Xenon lamp used in the 7205 but excludes the Tungsten lamp used in the 7200 which is covered by a 1 year warranty. In the event of a justified claim Cole-Parmer will replace any defective component or replace the unit free of charge. This warranty does NOT apply if damage is caused by fire, accident, misuse, neglect, incorrect adjustment or repair, damage caused by incorrect installation, adaptation, modification, fitting of non-approved parts or repair by unauthorised personnel.

Email: cpSERVICE@coleparmer.com

Tel: +44 (0)1785 810475

Web: www.jenway.com

فروشگاه تجهیزات آزمایشگاهی روناکو

SECTION 11 – Troubleshooting

11.1 POWER UP CALIBRATION FAILURE

Issue

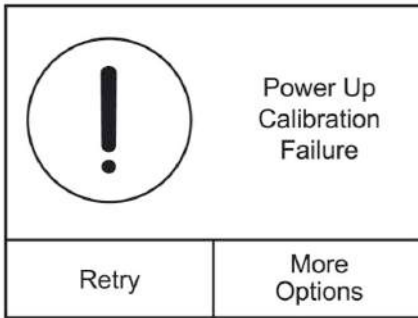

Explanation

Power up calibration failure

This is displayed if there is a failure when attempting a power up calibration.

Touch **Retry** to try the calibration again.

Touch **More Options** for lamp change or software update.



Touch **Update Software** to update the instrument with a new software version – refer to section 4.7 for more details.

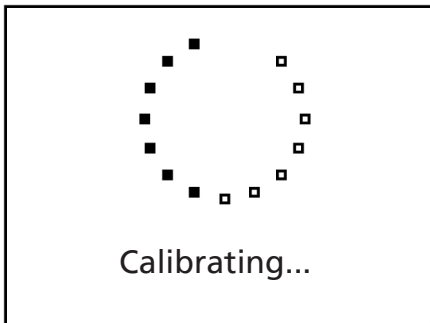

Touch **Lamp Change** to recalibrate the profile of the lamp. The lamp doesn't physically need to be removed. The instrument will then try to redo the startup calibration.

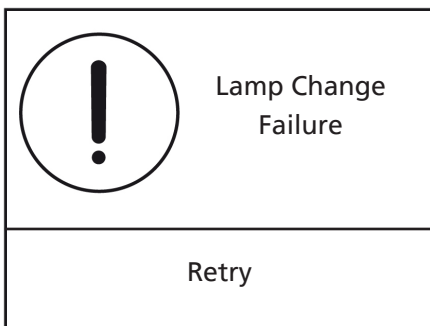





If the lamp recalibration isn't successful this error message will be displayed. Contact technical support or service.

فروشگاه تجهیزات آزمایشگاهی روناسی

11.2 ERROR CODES

The table below shows the error codes and solutions:

Issue	Explanation		
 <p data-bbox="359 526 606 555">No USB stick found</p>	<p data-bbox="758 280 997 309">No USB stick found</p> <p data-bbox="758 331 1404 392">Ensure a USB memory stick is inserted into the front USB port on the instrument.</p>		
 <p data-bbox="311 884 646 945">Couldn't find any standard curves</p>	<p data-bbox="758 660 1189 689">Couldn't find any standard curves</p> <p data-bbox="758 712 1444 806">There are no curve files stored on the USB stick. Ensure a USB memory stick is inserted into the front USB port on the instrument when the curve is saved.</p>		
 <p data-bbox="279 1265 678 1326">An error occurred deleting one or more files</p>	<p data-bbox="758 1041 1316 1070">An error occurred deleting one or more files</p> <p data-bbox="758 1093 1388 1153">Each selected curve is individually deleted – if there is a problem deleting one or more curves, this is displayed.</p>		
 <p data-bbox="518 1512 670 1572">Remove The Cuvette</p> <table border="1" data-bbox="260 1657 699 1747"> <tr> <td data-bbox="260 1657 486 1747">Retry</td> <td data-bbox="486 1657 699 1747">More Options</td> </tr> </table>	Retry	More Options	<p data-bbox="758 1422 1013 1451">Remove the cuvette</p> <p data-bbox="758 1473 1340 1601">Remove the cuvette from the sample chamber and touch Retry to try the calibration again. Touch More Options for lamp change or software update.</p> <p data-bbox="758 1624 1316 1691">If the problem persists, contact technical support or service.</p>
Retry	More Options		
 <p data-bbox="311 2027 654 2087">A communications timeout has occurred</p>	<p data-bbox="758 1803 1268 1832">A communications timeout has occurred</p> <p data-bbox="758 1854 1220 1915">If the problem persists, contact technical support or service.</p>		

Issue

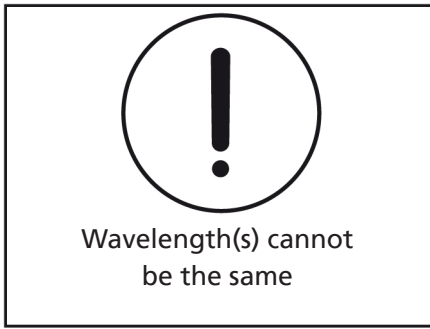

Explanation

Wavelength(s) cannot be the same

The start and end wavelengths of the spectrum scan cannot be the same value. Ensure that the start wavelength is lower than the end wavelength.

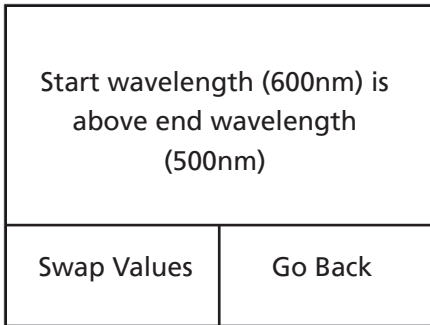

Start wavelength is above end wavelength

The start wavelength of the spectrum scan cannot be above the end wavelength. Ensure that the start wavelength is lower than the end wavelength.

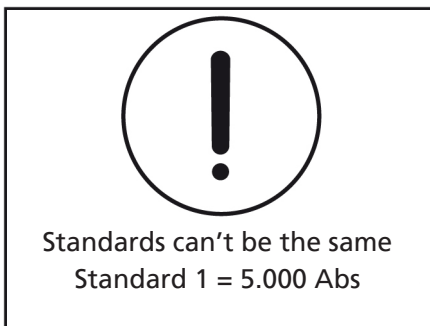

Standards can't be the same

When creating a standard curve the standards used must have different concentrations.

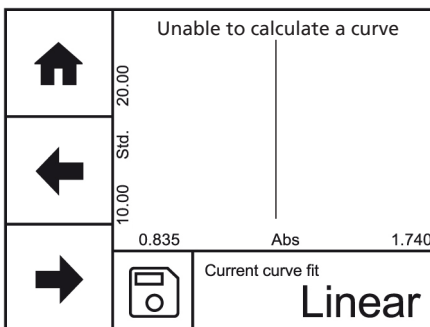

Unable to calculate curve

This can happen if the line of best fit is completely vertical. If either m or c calculate as infinity this error will be displayed. Ensure the standard concentration values have been inputted correct and the standards have been measured in the correct order.



Failed to send data to printer

Ensure an external printer is attached using the USB port on the rear of the instrument, that the printer is turned on and has paper in it.

فدر و شگاه نیریز از ما بپوشید

Issue

	Unable to start bootloader
retry	

Explanation

Unable to start bootloader

If the problem persists, contact technical support or service.

	Unable to start main application
retry	



Unable to start main application

If the problem persists, contact technical support or service.

	Unable to perform read
OK	

Unable to perform read

If the problem persists, contact technical support or service.

	Current Version 1.1.0/01.03 (14/07/16)
	Version on USB No update found on stick.
Load Software	

No update found on stick.

The USB memory stick doesn't contain a valid software update file. Ensure that the update has been saved to the USB memory stick.

One or more method parameters was out of range. File has not been opened.

One or more method parameters was out of range. File has not been opened

When reloading a curve from USB stick, all the parameters of the curve are checked to see that they are valid. If some of the parameters are out of range the file will not be loaded. Create a new standard curve.

11.3 TROUBLESHOOTING GUIDE

Issue	Solution
Unable to achieve zero absorbance or 100% transmittance when calibrating	Ensure that there is not a sample in the sample chamber. Ensure the lamp is working – if the lamp has failed please request service assistance.
Unable to achieve a reading when measuring a sample	Ensure the correct cuvette is being used so that light isn't being absorbed by the cuvette. Ensure the sample isn't too dense that light is not transmitted through the sample. Ensure the lamp is working. if the lamp has failed please request service assistance.
Unable to add additional points to the spectral points analysis table	The table can hold 50 points.
Unable to save results to the USB memory stick	Ensure the USB stick is inserted into the front of the unit. Ensure the USB memory stick has free capacity. Ensure there is a result displayed on the screen.
Fails start up calibration	Ensure that a 12V power supply is connected to the instrument. A smaller voltage power supply will be able to power the instrument but it will not provide enough power to drive the lamp.

11.4 TECHNICAL SUPPORT

Jenway have a dedicated Technical Support team made up of experienced scientists who are on hand to help with any applications advice and questions you may have about our products and how to use them. If you require any technical or application assistance please contact the team at:

E-mail: cptechsupport@coleparmer.com

Phone: +44 (0)1785 810433

SECTION 12 – Declaration of Conformity

CE This product meets the applicable harmonized standards for radio frequency interference and may be expected not to interfere with, or be affected by, other equipment with similar qualifications. We cannot be sure that other equipment used in its vicinity will meet these standards

and so we cannot guarantee that interference will not occur in practice. Where there is a possibility that injury, damage or loss might occur if equipment malfunctions due to radio frequency interference, or for general advice before use, contact the manufacturer.

JENWAY

Cole-Parmer

EU Declaration of Conformity

Product	Laboratory Equipment	File Number	P225
Manufacturer	Cole-Parmer Ltd Beacon Road Stone, Staffordshire ST15 0SA United Kingdom		

This declaration of conformity is issued under the sole responsibility of the manufacturer

Object of Declaration Scanning Spectrophotometer Range - 72 Series
(reference the attached list of catalogue numbers)

The object of the declaration described above is in conformity with the relevant Union Harmonisation Legislation:

Low Voltage Directive	2014/35/EU
EMC Directive	2014/30/EU
RoHS Directive	2011/65/EC

References to the relevant harmonised standards used or references to the other technical specifications in relation to which conformity is declared:

IEC/EN 61010-1:2010	Safety requirements for electrical equipment for measurement, control and laboratory use. Part 1: General requirements.
IEC/EN 61326-1:2013	Electrical equipment for measurement, control and laboratory use. EMC requirements. Part 1: General requirements (Class A).

Signed for and on behalf of the above manufacturer

Additional Information Year of CE Marking: 2016

Place of Issue Stone, Staffordshire, UK

Date of Issue 05 January 2017

Authorised Representative Steve Marriott

Title Technical Director

Signature 

Declaration of Conformity is also available to view online at www.jenway.com

 **Cole-Parmer®**

Cole-Parmer Ltd - UK

Beacon Road,

Stone,

Staffordshire,

ST15 0SA,

United Kingdom

Tel: +44 (0)1785 812121

Email: cpinfo@coleparmer.com

Web: www.jenway.com

فروشگاه تجهیزات آزمایشگاهی رونکو