

OPERATION MANUAL

PEN TYPE PH METER



CE

- Model:** ■ 8687, pH meter
■ 8688, pH meter
■ 8689, pH meter

INTRODUCTION

Congratulations on your purchase of this pen type pH meter. Please read the manual completely before using this meter. Filing and keeping the manual for future reference. Recommended to soak the electrode for at least 30 min. before using to clear up the lazy effect or to make the electrode wet if the pH electrode dries out.

Features:

- **IP65 Waterproof** housing.
- **Dual display** with ATC.
- **Replaceable** electrode
- **Data hold** to freeze readings.
- **Pen size**, easy to fit in pocket.
- **Low battery** indicator.
- **Auto power off**.
- **C/F** unit switchable.
- Power by 4pcs **LR44** batteries.
- **Multi points** calibration.
- **One touch** only for calibration.

MATERIAL SUPPLIED

This package contains:

- ✓ The meter x 1
- ✓ LR44 button battery x 4
- ✓ Operation manual x 1
- ✓ Wrist strap x 1
- ✓ Color box or plain box x 1

POWER SUPPLY

The meter is powered by 4 pcs LR44 batteries. To check the battery when:

1. First time use
2. The battery symbol appears on LCD
3. The meter can not power on

To install the batteries:

1. Turn off the meter.
2. Loosen the battery cover in counter-clockwise direction.
3. Replace the old batteries with four new button cells LR44.
4. Make sure the batteries are in place and the polarity is correct.
5. Put back the battery cover and turn it tightly in clockwise direction.

NOTE:

1. **Suggest to re-calibrate the meters after changing batteries.**
2. **Remove battery from instruments that you do not plan to use for a month or more. Do not leave battery in instrument.**

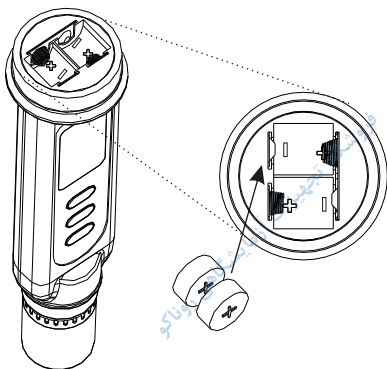

LCD DISPLAY



- The 1st display shows the measured pH reading.
- The 2nd display shows the temperature reading (degreeC or degree F)
- Cal=Calibration mode
- HLD=Data hold
- Battery icon to indicate low power
- uS/ppt/ppm/mS/mV are invalid units in this pH pen

KEYPAD



- Press to freeze the current reading.
- Press again to release hold.
- Press to adjust while in setting or calibration mode.



- Press to enter calibration mode.
- Press to save and enter next step while in setting mode
- Press to adjust while in calibration mode



- Press to power on/off the meter
- Press >2 second to enter setting mode before power on.
- Press with "HOLD" key to disable auto sleep function before power on.

OPERATION

1. Remove the semi-transparent cap to expose the electrode.
2. Dip the electrode into the test solution. Press "  " to power on the meter and tir it to get a stable reading.

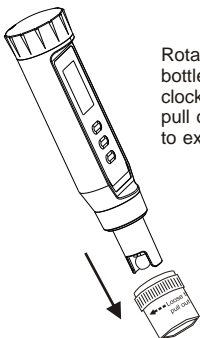



Rotate the semi-transparent bottle a little bit in counter-clockwise direction and then pull out the bottle completely to expose the electrode.





Electrode cap

3. "pH" flashes while the meter is in measurement mode. The LCD shows the measured pH and temperature. "pH" stop flash while the reading is stable.

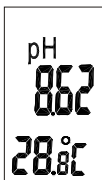
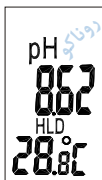

4. Press "  " key to freeze current readings. "HLD" appears on the LCD. Press "  " key again to release.



5. Turn off the meter by pressing "  " button.

6. Once finishing the measurement, clean the electrode, put back the electrode cap.

WARNING: For pH meters, please always make the electrode wet to keep the electrode in a good storage condition.



7. Please see page 8 for the calibration procedures.

8. Please see page 6 for the setting program.

AUTO POWER OFF (SLEEP FUNCTION)

This meter will shut off automatically 20 minutes of inactivity. For operating longer time, you can disable the sleep mode.

To disable the auto power off:

Before power on, pressing "  " + "  " keys simultaneously until a "n" appeared on the screen and then release keys to return to normal mode.



Note: The disable sleep mode will be invalid after every power off.

PARAMETERS SETTING

Parameters setting function could help you to check or program your meter.

When meter is off, press “” key >1 sec. to enter setting mode.

Probe slope and offset value

After re-calibration, check probe slope and offset value could help to confirm the necessity to replace the probe.

While doing 3 points calibration, two available slope values and one offset point.

Range 1 (SL1): 0.00 to 2nd point



Range 2 (SL2): 2nd point to 14.00pH.

Offset point is at pH7

Whiling doing 1 or 2 points calibration, the slope value SL1 equals to SL2.



The offset point is still at pH7.

Be sure to change probe while the slope value is <75 or >115 (The unit is %). While the offset value is out of -60mV~+60mV, change the probe as well.

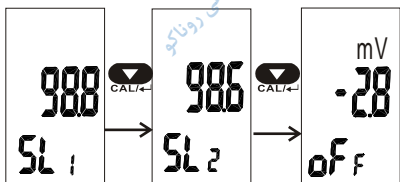
When meter is off, press “” key >1 sec. to enter setting mode. SL1 value will appear on LCD. Press “” key to view the SL2 value. Press “” key to view the offset value.



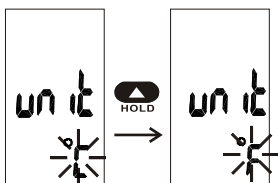

Temp. Unit Setting

To select the temp. unit ($^{\circ}\text{C}$ or $^{\circ}\text{F}$), enter the setting mode first. Press “” to select unit setting. Default unit flashes on LCD. Press “” to change and press “” to confirm.



Reset to default setting

To reset the meter to default setting, enter the setting mode first. Press “” to select reset. Default “no” flashes on LCD. Press “” to change and press “” to confirm.

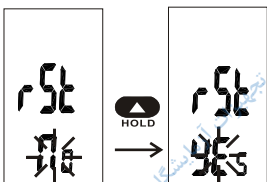

Before calibration, recommend to RESET the meter to delete all the old calibration information.

CALIBRATION MODE (CAL)

Calibration is necessary and should be done regularly, recommended everyday if the meter is used often. The unique calibration design of the meter features automatic buffer recognition to avoid errors.

1. Rinse the probe thoroughly with de-ionised water or rinse solution. Do not wipe the probe as this will cause a build-up of electrostatic charge on the glass surface.
2. Power on the meter.
3. Dip the probe into the standard calibration buffer. The end of the probe must be completely immersed into the sample. Stir the probe gently to create a homogeneous sample. Suggest to calibrate pH7 first and then 4 or 10 pH for better accuracy result.
4. Press "  " key > 1 second to enter calibration mode. The "CAL" icon, auto recognized buffer value (see below table) and "pH" will all flash on primary LCD.

Temp.(°C)	NIST		
	pH4.01	PH6.86	PH9.18
0	4.01	6.98	9.47
5	4.01	6.95	9.38
10	4.00	6.92	9.32
15	4.00	6.90	9.27
20	4.00	6.88	9.22
25	4.01	6.86	9.18
30	4.01	6.85	9.14
35	4.02	6.84	9.10
40	4.03	6.84	9.07
45	4.04	6.83	9.04
50	4.06	6.83	9.01

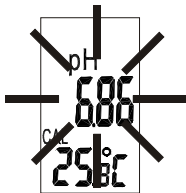



5. If the probe is damaged or the buffer is not specified as following, the primary LCD will keep flashing unless you escape by turning off the meter.

The acceptable pH buffer range:

- pH3.00~5.00
- pH6.00~8.00
- pH8.50~10.50

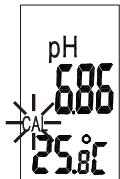
6. If the probe successfully recognizes the buffer, the buffer pH value and "CAL" will stop flashing.



7. If your calibration buffer is not NIST, press "" or "" to adjust the calibrating point to the corresponding buffer value of specific temperature. The adjustable range is :3.00 to 5.00, 6.00 to 8.00, 8.50 to 10.50.
8. Wait for 30 seconds, the meter completes the calibration automatically if the reading is stable enough.
9. Rinse the probe with de-ionized water or a rinse solution (tap water...) after calibration. Repeat step 3 ~ 8 to do multiple point calibration or exit by turning off the meter.

PROBE CHANGE

Suggest to change probe when:

1. Slow response
2. Unstable reading
3. Slope value is $<75\%$ or $>115\%$ or the offset value is out of $-60\text{mV}\sim+60\text{mV}$

Purchase the compatible pH probe from the store where you bought the pH pen.

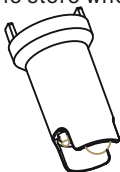

P/N: VZ86P8AZ

Package:

Pain box/manual

Suitable for:

8687/8688/8689 pH pen

Three steps to change the probe:

Step1: Loose the washer

Step2: Unplug the probe

Step3: Reverse steps to install new probe

NOTE: Be sure to calibrate the meter after changing the probe.

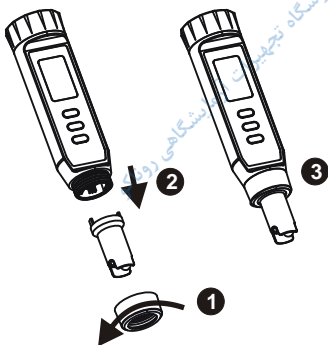

MAINTENANCE

- ✓ Please always keep the pH glass bulb wet by using the cap to protect and store the electrode.
- ✓ Always rinse the pH electrode in de-ionized water or rinse solution (tap water.....) before next use.
- ✓ Never touch or rub glass bulb in order to last pH electrode life.
- ✓ Make sure the electrode is clean. Between measurements, rinse the electrode with deionised water. If the electrode has been exposed to a solvent immiscible with water, clean it with a solvent miscible with water e.g. ethanol or acetone and rinse carefully with water.
- ✓ Store the electrode carefully.

TROUBLESHOOTING

◆ Power on but no display

- 1) Make sure the time of pressing power key is more than 0.3 sec.
- 2) Check the battery are in place and make good contact and correct polarity.
- 3) Replace new batteries again.
- 4) Move away the batteries for one minute and then put back again.

◆ Slow response

- 1) Clean probe by immersing the electrode in tap water for 10-15 min, then rinse thoroughly with distilled water or use a general purpose electrode cleaner.
- 2) Replace a new probe.

◆ Unstable reading

- 1) Stir it to make a homogeneous solution.
- 2) Make sure electrode is completely immersed in solution.
- 3) Clean probe and re-calibrate.
- 4) Replace a new probe
- 5) Move to another room and try again.

◆ The reading is changeless

Check whether the reading is hold?

Press “  “ key to unlock the reading.

◆ Error Code

E02: The value is below the lower limit

E03: The value is over the upper limit

E04: The Temp. error results in this error.

E13: Slope or offset value of pH probe is out of the range

Solution: Re-calibrate or replace a new probe or replace calibration buffer

E31: Measuring circuit failure

Solution: Power on meter for times, if error still appears, send back for repair

E32: Memory saving/reading failure

Solution: Power on meter for times, if error still appears, send back for repair

E33: Reference voltage failure

Solution: Power on meter for times, if error still appears, send back for repair

SPECIFICATION

SPECIFICATIONS 8687 8688 8689			
Accuracy ±	0.3pH	0.2pH	0.05pH
Cal.Point(4.7.10)			
Auto Power Off			
Measurement range			
	2.0-12.0	0.0-14.0	0.00-14.00
Temp. Accuracy			
	±1°C	±1°C	±0.5°C
Temp. Resolution			
	0.1°C/°F	0.1°C/°F	0.1°C/°F
Resolution			
	0.1pH	0.1pH	0.01pH
Hold Data			
Unit C/F switchable			
ATC (0~50°C)			
Auto recognize			
Waterproof (IP65)			
Size	176mm(L)x39mm(W)x39mm(T)		

- ✓ Operating Temp.: 0°~50°C (32~122°F)
- ✓ Operating Humidity: 0~80% RH
- ✓ pH calibration buffer suggested:
 - Standard USA buffers
 - Standard NIST buffers
 - Standard DIN buffers
- ✓ Battery Life: >200 hrs continuous use

فروشگاه تجهیزات آزمایشگاهی روناکو

WARRANTY

The meter is warranted to be free from defects in material and workmanship for a period of one year from the date of purchase. This warranty covers normal operation but does not cover battery, misuse, abuse, alteration, tampering, neglect, improper maintenance, or damage resulting from leaking batteries. Proof of purchase is required for warranty repairs . Warranty is void if the meter used to be taken apart.

RETURN AUTHORIZATION

Authorization must be obtained from the supplier before returning items for any reason. When requiring a RA (Return Authorization), please include data regarding the defective reason, the meters are to be returned along with good packing to prevent any damage in shipment and insured against possible damage or loss .

OTHER RELATED PRODUCTS

Other related pH products:

Benchtop Series

- a.86501/86551 pH,mV meter/printer
- b.86502/86552 pH, mV, ORP meter/printer
- c.86504/86554 pH, mV, ORP, Cond. meter/printer
- d.86505/86555 pH, mV, ORP, Cond.,TDS,Salinity meter
/printer

Handheld Series

- a.8601: pH, mV meter
- b.9861: pH, mV logger/ printer
- c.9661: pH, mV logger

Pen type Series

- a.8690: pH/temp. pen
- b.8680~8682: pH pen
- c.8684~8686: pH pen

Accuracy, the Zenith of Measuring / Testing Instruments !

Hygrometer/Psychrometer
Thermometer
Anemometer
Sound Level Meter
Air Flow meter
Infrared Thermometer
K type Thermometer
K.J.T. type Thermometer
K.J.T.R.S.E. type Thermometer
pH Meter
Conductivity Meter
T.D.S. Meter
D.O. Meter
Saccharimeter
Manometer
Tacho Meter
Lux / Light Meter
Moisture Meter
Data logger
Temp./RH transmitter
Wireless Transmitter

More products available !

2019/01