

OPERATION MANUAL

LABORATORY BENCHTOP METERS



CE

PRINTER SEIRES

- | | | | |
|---------|--------------------------|---------|---------------|
| ■ 86501 | pH/mV/Temp. meter | ■ 86551 | 86501+printer |
| ■ 86502 | pH/mV/ORP meter | ■ 86552 | 86502+printer |
| ■ 86503 | Conductivity/Temp. meter | ■ 86553 | 86503+printer |
| ■ 86504 | pH/mV/ORP/Cond. meter | ■ 86554 | 86504+printer |
| ■ 86505 | pH/mV/ORP/Cond./TDS/SALT | ■ 86555 | 86505+printer |

INDEX

	PAGE
● INTRODUCTION	1
● MATERIAL SUPPLIED	1
● POWER SUPPLY	2
● METER DRAWER	2
● ELECTRODE HOLDER	3-4
● LCD DISPLAY	5
● KEYPAD	6
● REAR PANEL	7
● OPERATION	8
— STARTING UP	8
— HOLD FUNCTION	9
— pH MEASUREMENT	10
— mV MEASUREMENT (± 499mV)	11
— ORP(mV) MEASUREMENT(± 1999mV)	12
— CONDUCTIVITY MEASUREMENT	13
— TDS (TOTAL DISSOLVED SOLID) MEASUREMENT	14
— SALINITY MEASUREMENT	15
— AUTOMATIC & MANUAL TEMP. COMPENSATION	16
— AUTO & MANUAL RANGE	17
— MEMORY RECORD	18
— MEMORY RECALL	18
— RECALL MAXIMUM & MINIMUM	19
● SETUP MODE	19
— P1.0 MEMORY TRANSMITTING	20
— P2.0 MEMORY CLEAR	20
— P3.0 VIEW SLOPE & OFFSET(PH PROBE)	21
— P3.0 VIEW CALIBRATION (COND. PROBE)	21
— P4.0 PH CALIBRATION BUFFER	22
— P4.0 CELL CONSTANT (COND. PROBE)	23
— P5.0 TEMPERATURE SETTING (COND. PROBE)	24
— P6.0 READY ICON	25
— P7.0 TEMPERATURE UNIT	26
— P8.0 REAL TIME CLOCK SETTING	26
— P9.0 RESET	27
● CALIBRATION	28
— PH PROBE CALIBRATION	28
— COND. PROBE CALIBRATION	29-31
— TDS CALIBRATION	32
— SALINITY CALIBRATION	33
● MAINTENANCE	33-36
● TROUBLE SHOOTING	37
● PC CONNECTION	38
● APPENDIX: COND. & TDS CONVERSION FACTOR	39-40
● PRINTING	41-42
● SPECIFICATION	43-45
● WARRANTY	45
● RETURN AUTHORIZATION	45

INTRODUCTION

Thank you for purchasing this benchtop meter. This meter is user-friendly and reliable. It comes with large LCD display. Please read this manual thoroughly before operation.

Features:

- Multi-display on big LCD screen.
- Automatic buffer recognition to avoid errors during calibration.
- Maximum 5 points calibration for pH benchtop meters.
- Hold function to freeze the record.
- Max./Min. review of memorized data.
- Reliable and replaceable probe with temp. compensation.
- Convenient to view calibration information of probe.
- "Ready" icon on LCD indicates the reading is stable.
- 99 memories and could be downloaded to PC for analysis.
- Automatic or manual temp. compensation are allowed.
- Analog output for chart recorders.

MATERIAL SUPPLIED

	86501 86551	86502 86552	86503 86553	86504 86554	86505 86555
Meter	✓	✓	✓	✓	✓
Adaptor	86501	86502	86503	86504	86505
Battery	86551	86552	86553	86554	86555
Probe (Incl.)	PH	PH	COND.	PH/COND.	PH/COND.
Probe holder	✓	✓	✓	✓	✓
Paper roll	86551	86552	86553	86554	86555
Manual	✓	✓	✓	✓	✓
RS232 + CD	✓	✓	✓	✓	✓
Box	✓	✓	✓	✓	✓
Optional		ORP probe		ORP probe	ORP probe

POWER SUPPLY

The benchtop meter is powered by 9VDC adaptor. Benchtop printer series are powered either by an adaptor or batteries. Please insert the batteries into the battery compartment with correct polarity and good contact.

There is one adaptor (I/P: AC 100-240V, 50/60Hz, 0.2A ; O/P: DC 9V, 0.65A) enclosed in each package (non-printing models). It is suggested to use this adaptor if you don't have any suitable adaptor meteed the above specification. The plug of the adaptor is USA type. Please buy a suitable plug converter if you are not using USA type plug.

Please see the power port on the rear panel.



METER DRAWER

There is a drawer built-in the bottom of the benchtop meter. (No drawer designed with benchtop printer series). Pull the drawer out to store your memorandum or important notes.

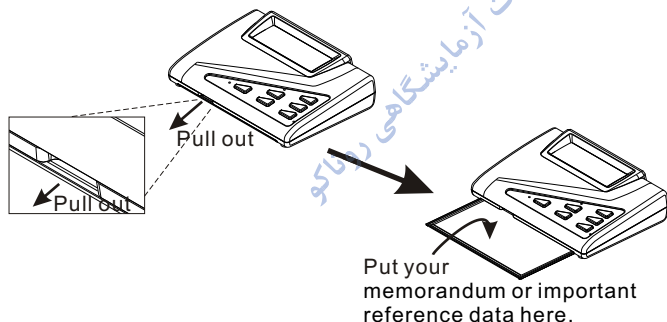

ELECTRODE HOLDER

The electrode holder is composed by two parts: base and arm. No need to use any tool to assemble the holder. The max. swing angle is 70 degree and the max. height of the holder is 378mm.

HOLDER ASSEMBLY

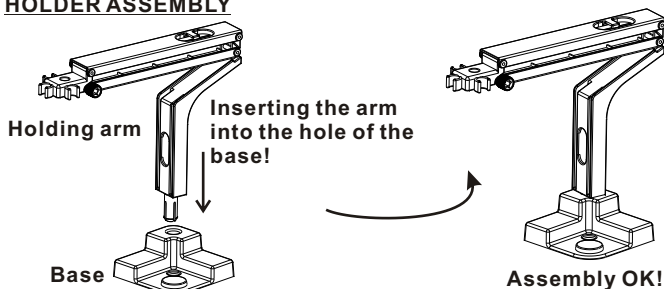

HOLDER DISASSEMBLY

To disassemble the holder from the base:

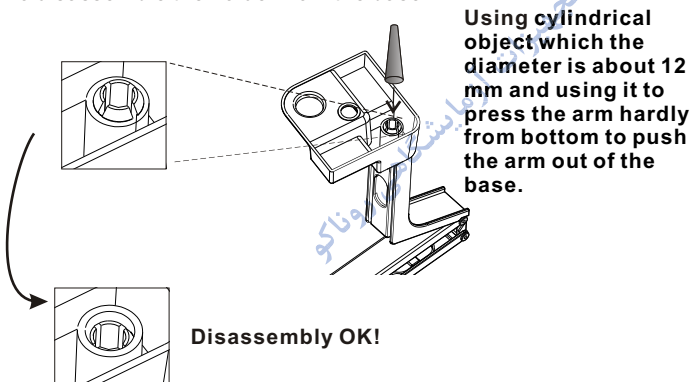

After assembling the holder, please attach the holder to the meter. There are two holes in the bottom of the meter which are used to hold the base. The holder can be fixed either on the right side or the left side of the meter.

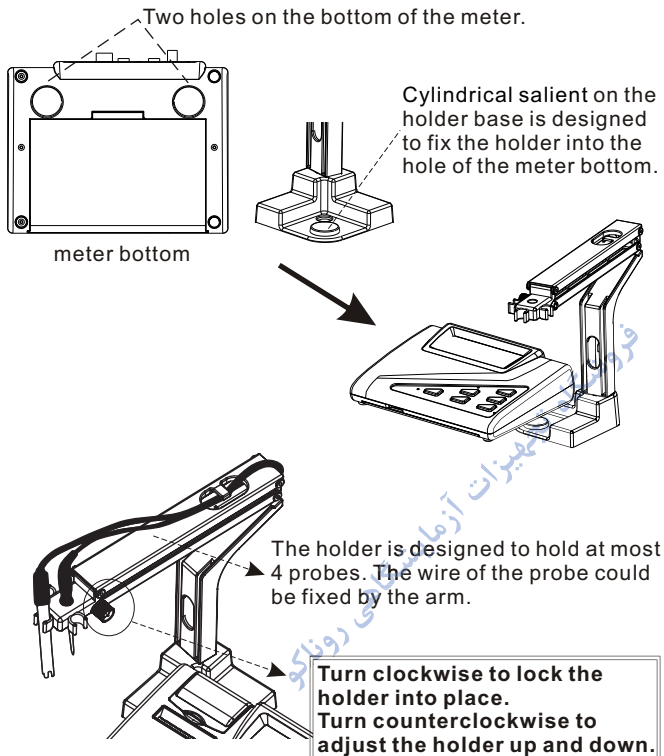

LCD DISPLAY



1. Primary Data Screen displays pH, mV, ORP, Conductivity, TDS or Salinity value.
2. Icons "**CON**", "**TDS**", "**SALT**", "**ORP**", "**pH**" or "**mV**" appear on the top of LCD to indicate the meaning of the displayed measured value.
3. Icons "**ppt**", "**pp m**", "**mg/l**", "**mS**", " **μ S**", "**kPA**" or "**mmHg**" indicate the unit of the displayed value.
4. "**READY**" icon indicates the reading is stable.
5. "**AUTO**" icon indicates the auto ranging function.
6. Icons "**MAX**", "**MIN**" indicate the maximum or minimum value of the memorized data.
7. "**HOLD**" icon indicates the reading is freezing.
8. "**REC**" icon indicates the meter is in recall mode.
9. "**MEM**" icon indicates the current measured value is saved.
10. The digital number under the "**MEM**" icon is the total numbers of records. For example, "**25**" means there are 25 records saved in the meter.
11. The "**Y-M-D / H:M:S**" are real time display.
 Y-M-D is Year-Month-Date. H:M:S is Hour: Minute: Second.
12. Icon "**ATC**" means the meter is in automatic temperature compensation mode.
13. The digital on the bottom of the LCD shows the temperature value. Temp. unit $^{\circ}$ C or $^{\circ}$ F is selectable.

KEYPAD

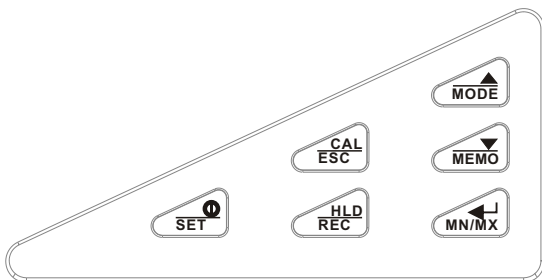

- Press to turn **ON/OFF** the meter. When the meter is powered on, it starts in the mode of last turned off.
- In normal mode, pressing > 1sec to enter **SET** mode.



- Switch between **normal** and **calibration** mode.
- Press to enter manual temperature setting.
- In calibration, setting or recall mode, press to return to normal mode.



- Press to freeze the reading on the display. Press again to release.
- Press more than 1sec to switch between **normal** and **recall** mode.



- Press to switch measuring mode.
- Press to increase the setting value.



- Press to save the current measurement.
- Press to decrease the setting value.



- Press to confirm the calibration or parameter setting.
- Press to view the max./min. of the memory in recall mode.
- Press to select **AUTO** or **Manual** ranging when Cond./TDS/SALT measurement mode.

REAR PANEL

The benchtop meter provides a complete set of input connectors for various accessories commonly used:

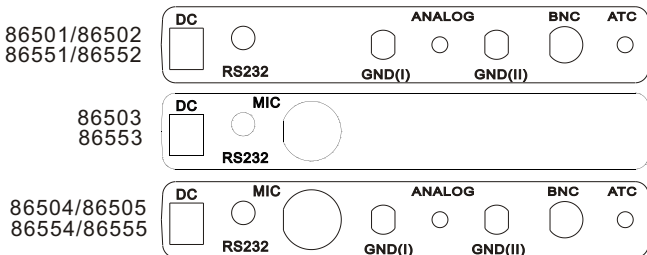

Connection

Function

- | | |
|----------------|--|
| DC | -For connection of the AC to DC adaptor power supply |
| RS232 | -For connection of the RS232 cable to pc to capture on-line or stored data. |
| MIC | -For connection of the conductivity probe to meter |
| GND(I) | -For connection to the earth ground jack (standard tip connectors) |
| GND(II) | -For connection to the earth ground jack (standard tip connectors) |
| ANALOG | -For connection to strip chart recorders. Use subminiature plug with positive tip. |
| BNC | -For connecting the electrode with a BNC connector. The port accepts pH, ORP with a BNC connector. Make sure the connector is clean and dry before connection. |
| ATC | -Phone jack connection from the temperature probe for automatic temperature compensation. |

OPERATION

STARTING UP

1. Assemble your electrode holder and install the holder to the meter. (See page 3 & 4)
2. Connect with an adaptor from AC power source to the power jack. Slide in the adaptor jack of the adaptor into the meter, make sure it is firmly seated. The meter's voltage is 9V.
(See page 2)
3. For pH and ORP measurement, connect a sensor electrode to the **BNC** port.
For Cond. TDS and Salinity measurement, connect a sensor electrode to the **MIC** port.
4. For pH probe with temperature sensor, connect a temperature sensor connector to **ATC** port.
5. Connect RS232 cable to meter and pc if you intend to upload real time measurement values and memories to pc for further analysis. (See page 38)
6. If needed, connect your chart recorder or other data collection devices to **ANALOG** port.

NOTE: Available measurable parameters of each model

MODEL	PROBE	PH	mV/ORP(mV)	Cond.	TDS	Salinity
86501/551	PH	●	●			
86502/552	PH ORP	●	● ●			
86503/553	Cond.			●		
86504/554	PH Cond. ORP	●	● ● ●		●	
86505/555	PH Cond. ORP	●	● ● ●		●	● ●

NOTE: The temperature of the measured liquid must be stable.

NOTE: pH and Con. Probe CANNOT be put in the same container while in measurement mode.

HOLD FUNCTION

This function lets you freeze the current readings on the display in normal measurement mode for all models. To hold the readings:

Step1

Press  key in measurement mode. "HOLD" icon appears on the display.

Step2

To release the held value, press  key again.

PH measurement
readings display in HOLD

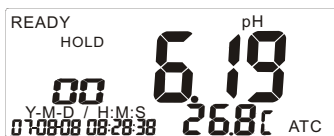

MV measurement
readings display in HOLD



ORP mV measurement
readings display in HOLD



Conductivity measurement
readings display in HOLD



TDS measurement
readings display in HOLD

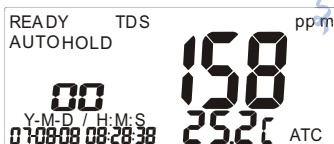

Salinity measurement
readings display in HOLD



pH MEASUREMENT

Taking pH readings from the models: 86501/86551/86502/86552/86854/86554/86505/86555. Measure range: 0~14pH.

This meter is designed to take measurement with automatic or manual temperature compensation. Automatic temperature compensation only occurs when a temperature sensor is plugged into the meter. For manual temperature compensation, the default setting is 25 °C. You can manually adjust the temperature to match your working conditions which is measured by a separate thermometer.

Be sure to remove the pH electrode soaker bottle from the electrode before measurement. To take the readings:

Step1

Rinse the probe with de-ionized or distilled water before use in order to remove any impurities adhering to the probe. If the electrode is dehydrated, soak it for 30 minutes in KCl solution.

Step2

Press  key to power on. "ATC" icon appears to indicate automatic temperature compensation probe is plugged.

Step3

Dip the electrode into the sample, the electrode must be completely immersed into the sample. Stir the probe gently to create a homogenous sample.

Step4

Wait until the reading stabilized. "Ready" icon will display on the top left corner of the LCD if this icon is activated in program setting P6.0 (See page 25)

Step5

To toggle between pH and mV, press  key.

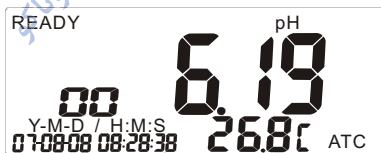

mV MEASUREMENT ($\pm 499\text{mV}$)

Taking **mV** measurements from the models:86501/86551/86502/86552/86504/86554/86505/86555. The mV measure range is from -499mV to +499mV with a pH probe.



Be sure to remove the **pH** electrode soaker bottle.

To take the readings:

Step1

Rinse the probe with de-ionized or distilled water before use in order to remove any impurities adhering to the probe. If the electrode is dehydrated, soak it for 30 minutes in KCl solution.

Step2

Press  key to power on the meter. Press  key to select **mV** measurement mode.

Step3

Dip the electrode into the sample, the electrode must be completely immersed into the sample. Stir the probe gently to create a homogenous sample.

Step4

Wait until the reading is stabilized. "**READY**" icon will display on the LCD if this icon is activated in setting program **P6.0** (See page 25)

Step5

To toggle between mV and pH, press  key.



ORP (mV) MEASUREMENT (± 1999 mv)

Taking **ORP (Oxidation Reduction Potential)** (mV) measurements from models: 86502/86552/86504/86554/86505/86555. The mV range is from -1999mV to +1999mV measured with an ORP probe. There are two kinds of ORP probe (Optional) for your selection:

P/N:850P (Regular performance, Pt pin)



P/N:86P5 (High performance, Pt band)

Be sure to use an **ORP** probe. Before measuring, please remove the electrode soaker bottle to take the readings:

Step1

Rinse the probe with de-ionized or distilled water before use in order to remove any impurities adhering to the probe.

Step2

Press  key to power on the meter. Press  key to select **mV** measurement mode.

Step3

Dip the electrode into the sample, the electrode must be completely immersed into the sample. Stir the probe gently to create a homogenous sample.

Step4

Wait until the reading is stabilized. "**READY**" icon will display on the LCD if this icon is activated in setting program **P6.0** (See page 25)

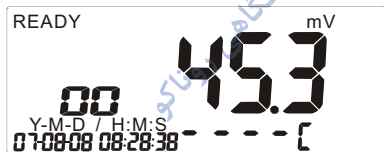

NOTE:

NO need to take Temp. Compensation into consideration when using an ORP probe and measuring.

CONDUCTIVITY MEASUREMENT

Taking **Conductivity** measurements from the models: 86503/86553/86504/86554/86505/86555. Two available Conductivity probes: P/N:830P (ABS body, graphite cell) & P/N:831P (Glass body, platinum cell). The **Conductivity** probe is used to measure TDS (Total Dissolved Oxygen) , SALT (Salinity) parameters, too.



The conductivity probe measures 0~19.99 μ S/cm, 0~199.9 μ S/cm, 0~1999 μ S/cm, 0~19.99mS/cm, 0~199.9mS/cm. In measurement, "**ATC**" icon appears in the lower right corner to indicate Automatic Temperature Compensation. If you select "**MTC**", "**ATC**" icon will disappear. When select "**MTC**", you have to first deactivate the "**ATC**" in **P5.1** (See page 24) and then set a "**MTC**" value.

Before measuring, please remove the electrode cover if needed. (See page 35). To take readings:

Step1

To rinse the probe with demineralized or distilled water.

Step2

Press  key to power on the meter. Press  key to select "**CON**" measurement mode. Before measuring, set the temp. coefficient first (See P5.2 in page 24).

NOTE:Tref (page 40) of the meter is set at 25°C and CANNOT be adjusted.

Step3

Dip the electrode into the sample, the electrode must be completely immersed into the sample. Stir the probe gently to create a homogenous sample.

Step4

Wait until the reading is stabilized. "**READY**" icon will display on the LCD if this icon is activated in setting program **P6.0** (See page 25)

Step5

To toggle between CON and TDS/SALT (86505/555), press  key.

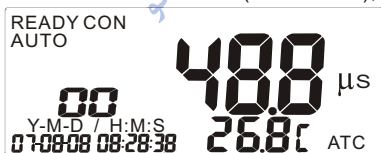

TDS (Total Dissolved Solid) MEASUREMENT



Taking **TDS** measurements from the models: 86505/86555. TDS readings display shows ppm or ppt and "**ATC**" icon appears in the lower right corner to indicate Automatic Temperature Compensation. If you select "**MTC**", "**ATC**" icon will disappear from the display. When select "**MTC**", you have to first deactivate the "**ATC**" in P5.1 (page 24) and then set a "**MTC**" value. (P5.3, page 25)

If needed, remove the Conductivity electrode cover (page 35) before measurement. It measures TDS ranges 0.00~9.99ppm, 0.0~99.9 ppm, 0~999ppm. To take the readings:

Step1

Please insert the probe into demineralized or distilled water to rinse the probe.

Step2

Press  key to power on the meter. Press  key to switch the mode to **TDS** measurement mode. Before measuring, set the temp. coefficient (P5.2 in page 24) and TDS conversion factor (P5.4 in page 25)

NOTE: Tref (page 40) of the meter is set at 25°C and CANNOT be adjusted.

Step3

Dip the electrode into the sample, the electrode must be completely immersed into the sample. Stir the probe gently to create a homogenous sample.

Step4

Wait until the reading is stabilized. "**READY**" icon will display on the LCD if this icon is activated in setting program P6.0 (See page 25)

Step5

To toggle between TDS and CON/SALT (86505/555),

press  key.

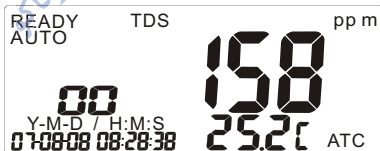

SALINITY MEASUREMENT



Taking **Salinity** measurements from models 86505/86555. Use a conductivity probe to measure salinity ranges: 0~80ppt(NaCl) with temperature compensation and temperature coefficient settings.

Before measuring, please remove the electrode cover if needed. (See page 35). To take the readings:

Step1

To rinse the probe with either demineralized or distilled water.

Step2

Press  key to power on, press  key to select "SALT" measurement mode.

Step3

Dip the electrode into the sample, the electrode must be completely immersed into the sample. Stir the probe gently to create a homogenous sample.

Step4

Wait until the reading is stabilized. "READY" icon will display on the LCD if this icon is activated in setting program P6.0 (See page 25)

Step5

To toggle between SALT and CON/TDS , press  key.



NOTE: pH and Cond. Probe CANNOT be put in the same container while in measurement mode.

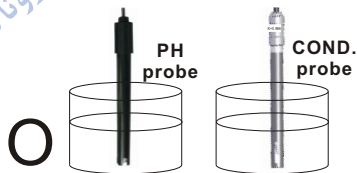
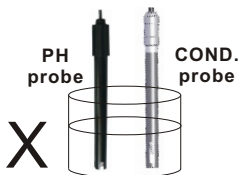

AUTOMATIC TEMPERATURE COMPENSATION (ATC)

With pH probe-

Plug the temp. Connector sensor into **ATC** port at the rear side of the meter.

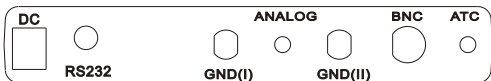

With conductivity probe-



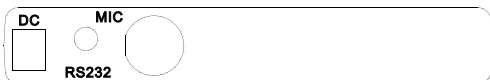

The temp. sensor is built-in the conductivity probe.

Only plug the probe into **MIC** port at the rear side of the meter.



MANUAL TEMPERATURE COMPENSATION (MTC)

With pH probe-

Simply disconnect the temp. connector from the rear side of the meter and select the mode as pH. To set the temp., press  key more than 1 second, "CAL" icon will flash on the LCD. Then, press  or  key to change the temperature value and press  key to save and return to normal measurement mode.

With conductivity probe-

The Temp. sensor is built-in the conductivity probe, just simply follow the manual temperature setting procedures in **P5.1 & P5.3** (page 24&25) to set the temperature.

NOTE: NO need to take temperature into consideration when using an ORP probe.

AUTO & MANUAL RANGE

You can select range function as automatic or manual by pressing  key when the meter is in measurement mode. This function is only available for the models: 86503/86553/86504/86554/86505 and 86555:

MODEL AUTO Range1 Range2 Range3 Range4 Range5

Cond. Full range 0~19.99uS 0~199.9uS 0~1999uS 0~19.99mS 0~199.9mS

TDS Full range 0~19.99*f ppm 0~199.9*f ppm 0~1999*f ppm 0~19.99*f ppt 0~199.9*f ppt

SALT Full range 0~11.38ppt 0~80.0ppt

NOTE: "f" stands for TDS conversion factor.

Normally, the meter will automatically select a range when readings appear. The purpose of having manual range function is for you to select the specific range (or corresponding resolution) that you want to work in.

1. When in measurement mode, press  key to select the range setting.
2. When select the range setting as automatic, the "AUTO" icon will appear on the left corner of the LCD.
3. When in manual range mode, if the measured value is out of range, E03 will appear on the LCD. Please select another range.
4. The meter will be reset to auto-ranging once it is turned off.

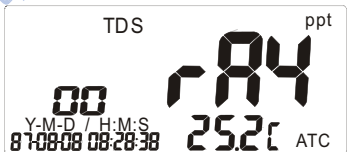
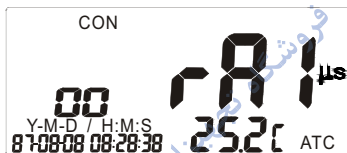

MEMORY RECORD

The following meters can store each parameter up to 99 records. For example, 86501 can store 99 pH values and 99 mV values.

MODEL	PH	mV/ORP(mV)	Cond.	TDS	Salinity
86501/551	99	99			
86502/552	99	99			
86503/553			99		
86504/554	99	99	99		
86505/555	99	99	99	99	99

To record:





1. In any measurement or **HOLD** mode, press  key to save data.
2. "**MEM**" icon displays on the LCD. Memory number & measured value will flash, then return to measurement mode.



NOTE: The new data could not be saved into meter if the memory is full. To continuously save new memory, it is needed to clear up existing 99 memories.

MEMORY RECALL

This function can recall previous readings which are stored in the memory.



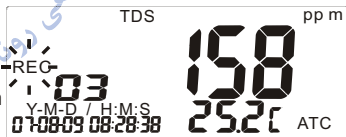

1. Press  key > 2 seconds to enter **recall** mode. "**REC**" icon will flash on the LCD.
2. Press  key to select next memory or press  key to select previous memory.
3. To exit memory recall, press  key > 2 seconds to return to measurement mode.



NOTE: All records are retained even if the meter is turned off. To clear records please see page 20.

RECALL MAXIMUM & MINIMUM

To view the maximum or minimum values from stored memory:

1. Press  key > 2 seconds to enter the **recall** mode. "REC" icon will flash on the LCD.
2. Press  key to view the minimum value of memory.
Press  again to view the maximum value of memory.
3. To exit memory recall, press  key > 2 seconds to return to the measurement mode.





NOTE: Stored memories are retained even if the meter is turned off. To clear records, please see page 20

SETUP

The advanced **SETUP** mode lets you customize your meter's preferences and defaults.

	86501	86502	86503	86504	86505
	86551	86552	86553	86554	86555
P1.0 Memory transmitting	●	●	●	●	●
P2.0 Memory clear	●	●	●	●	●
P3.0 Electrode (pH probe) or CAL view (Cond. Probe)	●	●	●	●	●
P4.0 Buffer solution (pH) or CELL (Cond. Probe)	●	●	●	●	●
P5.0 Temp Setting			●	●	●
P6.0 Ready Function	●		●	●	●
P7.0 Temp. Unit	●	●	●	●	●
P8.0 Real time clock	●	●	●	●	●
P9.0 RESET	●	●	●	●	●

To enter the **SETUP** mode, press  key >2 seconds when meter is in measurement mode.

NOTE: To exit the function without saving, press  key until the measurement mode appears. If the meter is under the **SETUP** mode, press  key twice to escape.

P1.0 MEMORY TRANSMITTING-ت

To transmit the stored data from meter to pc (through Rs232 interface) and to printer device series (86551~555 ONLY).

STEP1

Connect the phone jack of RS232 cable to the rear side of the meter then connect D-sub connector to your pc. Use Windows Hyper-terminal to view the data.

STEP2

Enter the setup mode as describe in page 19. "ت" icon appears on the upper LCD and P1.0 displays under "ت".



STEP3

Press  key to enter P1.1 "out" icon flashes on the upper LCD and P1.1 displays under "out". It means the memories are under transmitting. After transmitting, the LCD will return to P1.0 mode.



NOTE:

The meter can store up to 99 records for each parameter. If you want to transmit the data, press  key to select the parameter you desired before entering setup mode.

P2.0 MEMORY CLEAR-ت

To clear the stored data from meters:

STEP1

Press  key to select the parameter you want to clear before entering setup mode.

STEP2

Enter setup mode as describe in page 19. Press  key to select memory clear function "ت" icon appears on the upper LCD and P2.0 shows on the lower LCD.





STEP3

Press  key to enter P2.1. "no" icon flashes on the upper LCD and P2.1 shows on the lower LCD.



STEP4

Press  key to change the status from "NO" to "YES". Then press  key again to confirm clearing all memories. The LCD will return to P2.0 when memories are deleted.



NOTE:

The memory clear program is designed to clear 99 memories at one time. Please consider carefully if you decide to clear the memory. This operation can not be recovered.

P3.0 ELECTRODE-pH probe-ELLE

To view the pH electrode data (slope & offset value) from meters (86501/86551/86502/86552/86504/86554/86505/86555):

STEP1

Press  key to select electrode type as pH. Enter setup mode as describe in page 19. pH "ELLE" icon appears on the upper LCD and P3.0 shows on the lower LCD.



STEP2

Press  key to enter P3.1, upper displays one of 4 available slope values (P3.1-P3.4), If the value is <75% or >115%, suggest to change electrode immediately.



NOTE: The definition of solution range is different between NIST and CUST buffers.



STEP3

Press  key to enter P3.2, P3.3 & P3.4.



STEP4

Press  key to enter P3.5 to view the offset value.



Offset value is the mV value of pH 7 and the default offset value is 0.0. The offset value will be different after calibration. Once the value is out of ± 60 mV, strongly suggest you to replace with a new probe.

NOTE: Slope definition of each range & buffer.

	P3.1	P3.2	P3.3	P3.4
NIST	0.00~4.01	4.01~6.86	6.86~9.18	9.18~14.00
CUST	0.00~4.50	4.50~7.00	7.00~9.50	9.50~14.00

P3.0 CAL View-Cond. Probe-



This program helps you to know which range has been calibrated and what is the last calibration value. The program is only for "review" the electrode calibration data of **Cond.** or **TDS** or **SALT**. For example: 86505, if the range is not yet calibrated, the LCD will show the default value.

There are total 5 calibration ranges for **Cond.**, **TDS** and **SALT**. For range 1~3: It could be Cond. or TDS value.

For range 4~5: It could be Cond. or TDS or SALT value.

Available models are 86503/86553/86504/86554/86505/86555:

STEP1

Press  key to select electrode program. Enter **setup** mode as describe in page 19. Select the setup program as **CAL**, " icon appears on the upper LCD and the **P3.0** shows on the lower LCD.

STEP2

Press  key to enter **P3.1**. There are up to 5 available ranges (**P3.1** to **P3.5**).

STEP3

Press  key to enter **P3.2**, **P3.3** ... **P3.5**.

The default values of this program are:

Range1	Range2	Range3	Range4	Range5
14.13uS	141.3uS	1413uS	14.13mS	141.3mS



Example: 86505

P4.0 PH BUFFER -pH probe-

Two available buffer types for meters 86501/86551/86502/86552 86504/86554/86505/86555 are:

NIST buffer: PH1.68; 4.01; 6.86; 9.18; 12.45

CUST buffer (Custom buffer), 5ranges:

PH1.00~3.00; 3.50~5.50; 6.00~8.00; 8.50~10.50; 11.50~13.50

STEP1



This meter allows you to select two different types pH buffer: NIST type or your own custom buffer type. To select correct buffer you are using can help meter to recognize the buffer and calibrate the probe more precisely.

STEP2

Enter setup mode as describe in page 19. Press  key to select pH buffer program. "buf" icon appears on the upper LCD and the P4.0 shows on the lower LCD.



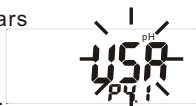

STEP3

Press  key to enter P4.1. "USA" icon appears on the upper LCD and the P4.1 shows on the lower LCD. If your buffer is NIST type, press  key to confirm and LCD will return to P4.0.



STEP4

If your buffer is not NIST, press  key to change the status. Then, press  key to confirm and LCD will return to P4.0.



P4.0 CELL CONSTANT-Cond.Probe-[CELL]

To view electrode data (cell constant) of each range from meters (86503/86553/86504/86554/86505/86555):

Example: Conductivity 86503

If the range is not calibrated yet, the LCD will show the default value (1.000).

STEP1

Press  key to select electrode program. Enter setup mode as describe in page 19. Select setup program as CELL. "CELL" icon appears on the upper LCD and the P4.0 shows on the lower LCD.



STEP2

Press  key to enter P4.1. There are up to 5 available ranges (P4.1 to P4.5).



STEP3

Press  key to enter **P4.2, P4.3 ... P4.5.**



NOTE:

Cell constant may degrade with time and usage.
User can use this feature as a reminder of changing a new probe.

P5.0 TEMP. SETTING -Cond. Probe- [COEF]

Use this program to set temperature related parameters and TDS conversion factor for models: 86503/553/504/554/505/555.



The programmable parameters are:

Parameters	Range	Default
P5.1 ATC/MTC	AUTO or NAn (Non-Auto)	AUTO
P5.2 Tc (Temp. Coefficient)	0.0%/C ~ 10.0%/C	2.1%/C
P5.3 Manual temp. Calibration	0.0°C ~ 93.0°C	25°C
P5.4 TDS factor	0.300 ~ 1.000	0.500

STEP1





Press  key to select electrode program. Enter the setup mode as describe in page 19. Select the setup program as Coef. "[COEF]" icon appears on the upper LCD and **P5.0** shows on the lower LCD.

STEP2

At **P5.0**, press  key to enter **P5.1.** "Auto" icon appears on the upper LCD and the **P5.1** shows on the lower LCD. If the temperature compensation mode you need is manual, then press  key to change the status and then press  key to confirm and enter program **P5.2.**







STEP3

At **P5.1**, press  key to enter **P5.2.** "2.1" icon will appear on the upper LCD and the **P5.2** shows on the lower LCD. If the temperature coefficient you need is not **2.1**, press  or  key to change, then press  key to confirm and enter program **P5.3.**

STEP4

When you set the temperature compensation mode as manual (MTC), it is needed to set solution temperature in P5.3







At P5.1, press  key twice to enter P5.3. "25.0" icon appears on the upper LCD and the P5.3 shows on the lower LCD. If the solution temperature you measured is not 25, press  or  key to change the value and then press  key to confirm and enter program P5.4.

STEP5

When you select the measurement mode as TDS, it is needed to set the TDS conversion factor in P5.4



At P5.1, press  key triplet to enter P5.4. "0500" appears on the upper LCD and the P5.4 shows on the lower LCD. If the TDS conversion factor of the solution is not 0.5, press  or  key to change the value and then press  key to confirm and return to program P5.0.

P6.0 READY ICON - rdy



Use this program to decide whether the ready icon will display or not. When selecting YES, "rdy" icon will appear when the measured reading is stable.

STEP1

Enter the setup mode as describe in page 19. Press  to select the "ready" program. "rdy" icon appears on the upper LCD and the P6.0 shows on the lower LCD.



STEP2

At P6.0, press  key to enter P6.1. "YES" flashes on the upper LCD and the P6.1 shows on the lower LCD. If you want "READY" icon displays on the LCD press  key to confirm.



STEP3

If you don't want the "READY" icon display, press  key to change the status from "☀️" to "☀️" and then press  key to confirm. The LCD will return to **P6.0**.



P7.0 TEMPERATURE UNIT - ٤٤



To select the unit of the temperature:

STEP1

Enter the setup mode as describe in page 19. Press  key to select the temp. unit program. "٤٤" icon appears on the upper LCD and the **P7.0** shows on the lower LCD.





STEP2

At P7.0, press  key to enter **P7.1**. "°C" icon appears on the upper LCD and the **P7.1** shows on the lower LCD. If the unit you needed is °C then press  key to confirm.



STEP3

If the unit you needed is °F, press  key to change the status from "°C" to "°F" and then press  key to confirm. The LCD will return to **P7.0**.



P8.0 REAL TIME CLOCK - ٤٤

Use this program to adjust local time of the meter. A CR2032 battery inside drives the real time clock, so the real time clock will not be suspended even the meter is off.

Symbol	Y-M-D	H:M:S
Meaning	Year-Month-Day	Hour-Minute-Second
Range	99-12-31	23-59-59

STEP1

Enter the setup mode as describe in page 19. Press  key to select **real time clock** program. "٤٤" icon appears on the upper LCD and the **P8.0** shows on the lower LCD.





STEP2

At **P8.0**, press  key to enter **P8.1**. The year value flashes on the left corner.



STEP3

Press  or  key to select the value of year. Press  key to confirm. Now the display enter **P8.2** and the month value will flash to indicate it is ready for editing.



STEP4

Repeat step3 to select the value of month and enter Day, Hour, Minute, Second setting in turns





P9.0 RESET -

Use this program to reset the meters to factory default setting.

STEP1



Select the mode you want to reset before entering set up mode. When select PH/mV, only PH & mV related parameters will be reverted to default value. COND./TDS/SALT parameters will not be reset unless you select the mode as COND./TDS/SALT. See page 44~45 for default value of each parameter.

STEP2

Enter the setup mode as describe in page 19. Press  key to select the reset program. " " icon appears on the upper LCD and the **P9.0** shows on the lower LCD.







STEP3

At **P9.0**, press  key to enter **P9.1**. " " icon appears on the upper LCD. If you don't want to reset, press  key to confirm.



STEP4

If you want to reset the meter, press  key to change the status from " " to " " and then press  key to confirm. The LCD will return to **P9.0**.



CALIBRATION

PH PROBE CALIBRATION

We recommended that you operate at least a 2-point calibration. If you can only perform a 1-point calibration, please make sure the buffer value is near to the sample you are measuring and the buffer temperature must be stable enough.

STEP1

Power on the meter and press  key to select the **pH** mode. Rinse the electrode in deionized water or rinse solution. DON'T wipe the pH probe dry. Wiping the probe may cause static and cause calibration and measurement instability.

STEP2



Select the pH buffer and pour some into a clean container. Dip the probe into the buffer. The end of the probe must be immersed into the buffer. Stir the probe gently to create a homogenous sample.

STEP3

Press  key to enter the **calibration** mode. "CAL" icon will flash on the left of the LCD. The upper LCD shows the measured value but the lower LCD is depended on the buffer type (See page 22)



STEP4

- If choose NIST, the lower LCD shows the real value of buffer at current temp. If this value keeps changing means the buffer or probe need to be checked. (refer to trouble shooting, page 37)
- If choose CUST, the lower LCD shows the default 2.00, short press  key to select the buffer range (page 22) you are using. Then press  or  key to adjust the secondary value meet with buffer value at current temperature.

STEP5

Once the measured pH value is stable and if you have set **Ready** function in **P6.1**, "READY" icon will display on the upper LCD. Press  key to confirm.

STEP6

Change buffer & repeat step 4~5 to do multiple points calibration or press  key to end the calibration and return to normal mode.

NOTE:

When in calibration, the buffer temperature must be stable enough.

CONDUCTIVITY PROBE CALIBRATION

SELECT CALIBRATION STANDARD SOLUTION

For best results, it is suggested to select an appropriate conductivity, TDS or NaCl standard which is near the sample value you are measuring. Alternatively, use a calibration solution value which is approximate 2/3 of the full scale of the measurement range you plan to use.

For example, in the 0 to 1999 μS range, use 1413 μS solution for calibration.

DO NOT reuse the calibration solution. Contaminants in the solution will affect the calibration and the accuracy. Be sure to use fresh solution each time.

Refer to below table. Strongly suggest to use the recommended calibration solution for different conductivity and TDS ranges.

Range	Conductivity Measuring	Calibration Solution
1	0~19.99 μS	6.00~17.00 μS
2	0~199.9 μS	60.00~170.0 μS
3	0~1999 μS	600~1700 μS
4	0~19.99 mS	6.00~17.00 mS
5	0~199.9 mS	60.0~170.0 mS

Range	TDS Measuring (factor=0.5)	Calibration Solution
1	0.00~9.99 ppm	3.00~8.50 ppm
2	0.0~99.9 ppm	30.0~85.0 ppm
3	0~999 ppm	300~850 ppm
4	0.00~9.99 ppt	3.00~8.50 ppt
5	0.0~199.9 ppt	30.0~85.0 ppt

The previous calibration data will be replaced after re-calibration again. For example, if you previously calibrated conductivity meter at 1413 μS , when you recalibrate it at 1500 μS again (also in the 0 to 1999 μS range), the previous 1413 μS will be replaced. However, the meter will retain the calibration data for other ranges which are not yet re-calibrated.

NOTE:

The temperature coefficient of the meter is defaulted at 2.1% per $^{\circ}\text{C}$ and provides good results for most applications. Please see **P5.2** on page 24 if you need to reset the coefficient.

WHEN SHOULD YOU DO THE CALIBRATION?

For first using, strongly suggest you to use solution to calibrate

If the conductivity of measured solutions is $<100\mu\text{S}$, or TDS is <50 ppm, please calibrate the meter at least once a week to get specified accuracy.

If the meter is used in the mid range, it is needed to do calibration at least once a month.

If the measurement is proceed at extreme temperature, suggest to calibrate at least once a week.

To proceed the conductivity calibration.

STEP1

Insert the probe into demineralized water or distilled water for about 30 minutes to rinse the probe.

STEP2

Select the conductivity standard for calibration. (See page 29)

STEP3

Pour the solution at 4 cm height into two separate clean containers (A&B). Rinse the probe into one of above containers. Gently stir the probe.

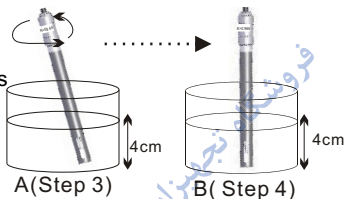

STEP4

Dip the rinsed probe into the other container. Tap probe on the bottom of container to remove air bubbles. Let the probe stabilize to the solution temperature.



STEP5

In measurement mode, press  key to select the mode as **CON** and press  key to enter calibration mode. The probe will measure the conductivity value of solution and blinks the value on the LCD.

STEP6

Wait for the measured Cond. value to be stable. If you have set **READY** function in 6.1. "READY" icon will show on the upper LCD when the calibration is stable.

STEP7

Press  or  key to change the value on the upper LCD to match the value of standard buffer. There are two options. Whatever you choose, the temp. coefficient must be set as follows. Then, press  key to confirm the calibration.



A) To input the value based on current temperature:

Tc (See page 24) must be 0.0

B) To input the value based on 25°C:

Please refer to Appendix C (See page 39) to select the Tc value.

NOTE:

You can adjust the conductivity reading up to $\pm 20\%$ from the measured value. However, if your measured value differs standard value $\pm 20\%$, it means cleaning or replacing probe is needed.

Example:

Standard: 10uS; measured value: 19uS

Adjustable range is $\pm 3.8\text{us}$ ($19 \times 20\%$), the measured value exceeds the range $\pm 3.8\text{us}$, to clean probe or replace with a new probe is necessary.

NOTE:

When the calibration is stable, the "Ready" will display on the LCD. If you don't find "Ready" display, please check the calibration solutions and make sure: Is the solution stable? Is the input value in step7 correct? Is the "Ready" icon activated.

NOTE:

If standard value is over measuring range or 10% less, the displayed value will be equal to the range limit or 10% of range limit. Under this condition, user should go to parameter setting first to manually select a suitable range. (See page 17)

Example 1:

Standard: 22uS; measured value: 19uS

Adjustable range: $\pm 3.8\text{us}$ ($19 \times 20\%$)

Although the values differ less than 20%, the 22uS is still over range limit (because the maximum input value is 19.99uS). So, you have to manually select the range as 0~199.9uS and then adjust the value to 22uS.

Example 2:

Standard: 1.6uS; measured value: 2.1uS

Adjustable range: $\pm 0.42\text{us}$ ($2.1 \times 20\%$)

Although the measured value differs less than 20%, the 1.6uS is still less than 10% range limit ($19.99 \times 10\%$). So, the max. input value can be only 2.00uS.

TDS CALIBRATION

There are two available options to do the TDS calibration

OPTION1: USE TDS STANDARD SOLUTION

The procedure of TDS calibration is almost the same as conductivity calibration. Only two extra notes for TDS calibration.

NOTE1:

Select the **TDS** standard for calibration. Default TDS conversion factor is 0.50. If your solution has a different TDS factor, you can improve the calibration accuracy by setting the TDS factor before starting the calibration. To set the TDS factors to the correct value, please see Appendix A(See page 39) or refer to the value provided by standard solution manufacturer.

NOTE2:

In measurement mode, press  key to select the mode as **TDS** and press  key to enter calibration mode.

OPTION2: USE CONVERSION FACTORS

TDS values are related to conductivity. You can calibrate the meter by using conductivity standards as describe above and then program the meter with a given conversion factor.

1. Perform the conductivity calibration procedure on page 29~31.
2. Select the correct Conductivity-to- TDS conversion factor. You can refer to Appendix A or calculate the TDS conversion factor for other solutions using the formula shown in Appendix B
3. Refer to **P5.4** in page 25 to check the procedures of how to set the factor.

SALINITY CALIBRATION

The procedure of **SALINITY** calibration is almost the same as conductivity calibration. Only two extra notes for salinity calibration.

NOTE1:

In measurement mode, press  key to select the mode as **SALT** and press  key to enter calibration mode.

NOTE2:

There are two measuring ranges for salinity: 0 to 11.38 ppt and 0 to 80.0 ppt. Please select a NaCl standard which is near the sample value you are measuring.

PROBE MAINTENANCE

PH PROBE

It is important to keep pH probe wet when the meter is in storage.

The probe is well protected by a plastic bottle with solution in it. To use or store the probe.

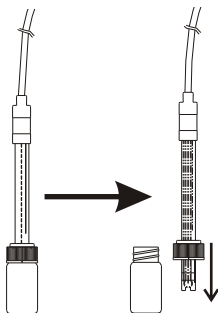

Step1

Rotate the bottle to remove the bottle away from the probe.

Step2.

Pull down the cover and remove it from the probe.

After using, first put back the cover on to probe, plug the probe into bottle and then rotate the bottle to fit into the cover tightly.

KEY NOTES OF pH PROBE MAINTENANCE:

- ✓ Always keep the pH glass bulb wet by using the plastic bottle to protect and store the electrode, you can also store in a 3M KCL solution. Never use distilled water for storage.
- ✓ Always rinse the pH electrode in de-ionized water before next use.
- ✓ Never touch or rub glass bulb for lasting pH electrode life.
- ✓ This probe is designed with fiber junction. To prolong the life of the electrodes, it is recommended to clean them monthly by immersing with cleaning solution for half an hour. Afterwards, rinse it with tap water and re-calibrate with the meter.
- ✓ The other way to prolong the life of the electrodes is to extend the fiber junction and cut the dirt portion.

The extendable fiber junction is used to eliminate the reading errors from clogged junction.

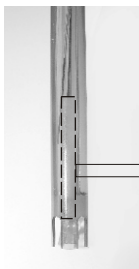

Extendable
fiber junction

To expose the new unused portions:

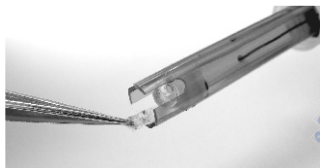

Step1

Use tweezers to pull out the fiber junction and expose the new unused portion.



Step2

Cut the clogged fiber and expose the new portion.

CONDUCTIVITY PROBE

Preparation:

Before using, soak the conductivity probe in distilled water for 30 minutes to avoid testing element become indolent.

There is a cover on 831P probe. Suggest to leave the cover on probe but you could also remove it before calibration & measurement.

Note:

If removing the cover, the probe must be both uncapped in calibration and measurement mode.

Maintenance:

- ✓ DO NOT use hard object to touch the surface of testing element of conductivity electrode.
- ✓ DO NOT use anything to rub the platinum black surface of electrode either, or the original constants will be changed and testing range will be affected.
- ✓ If the surface of testing element is contaminated, put the probe into diluted detergent or diluted acid for about 15 minutes. And then rinse it with distilled water.

ORP PROBE

Preparation:

Before using, remove the soaking bottle, then soak the electrode into distilled water. Rinse it then take out and make dry. Now the electrode is ready for measurement.

NOTE: DO NOT rub sensing element forcibly

Test the electrode:

- ✓ Connect the ORP electrode to meter and make sure the connection is correct.
- ✓ Put the electrode in buffer solution of pH7.00 with saturated quinhydrone. After stirring, mV reading (E1) should be 86 ± 15 mV.
- ✓ Rinse the electrode with distilled water, then set it in buffer solution of pH4.01 with saturated quinhydrone. After stabilizing, record mV meter reading (E2). The difference between E1 and E2 should be 165 mV.

Storage:

- ✓ Rinse the electrode with distilled water during the interval of each use.
- ✓ Keep the ORP electrode wet. If not use for a long time, it should be rinsed and stored in the provided soaking bottle which is filled with soaking solution.

ORP electrode cleaning:

If the sensing element got contaminated, it will result in slow response and inaccurate reading. Clean it as follows:

- ✓ If the contamination is a mineral matter, put sensing element in 0.1N HCL solution for 10 minutes and then rinse it with distilled water.
- ✓ If the contamination is oil or grease coating, clean sensing element with detergent and rinse it with distilled water.
- ✓ After above treatments, put the electrode in saturated buffer pH4.01 for 15 minutes and then rinse it with distilled water.

NOTE:

After cleaning, soak the electrode in solution at least 8 hours, it may be used again.

Electrode response time and accuracy:

Sensing element of the ORP electrode is made of high purity metal, it truly reflects the tested solution's ability of oxidation-reduction, but slow response time and inaccurate reading may occur from time to time.

It is because that sensing element of the electrode was soaked in a certain solution for a long time and an oxidation-reduction coating was formed outside. A simple way to solve this problem is to clean the probe.

Moreover, because concentration of oxidation-reduction matter is low and ion exchange rate is slow, they may also cause slow response and inaccurate reading. Under this condition, it may take 8-24hours to get a reliable and correct reading.

TROUBLE SHOOTING

? METER COULD NOT BE POWERED ON

- Press "**POWER/SET**" key > 0.3sec.
- Check the connection status of adaptor

? UNSTABLE READING

- Stir the solution to make a homogeneous status and make sure the sensor is completely immersed in solution.
- Make sure the measurement is processed in container.
- Clean or re-calibrate or replace with a new probe.
- Move to another room and try again, it is supposed that the unstable reading is caused by strong RF interference field.

? THE READING IS NOT CHANGED

- If the status is in "**HOLD**", release the status.
- If the measurement is in **MTC**, input temperature value.

? SLOW RESPONSE

- Clean and re-calibrate the probe.
- Replace with a new probe.

? WRONG REAL TIME

- The wrong real time display will not affect the measurement. Contact the distributor to purchase battery and acquire replacement procedures.

? ERROR CODES STAND FOR

Error	Problem
E02	The value is under the lower limit.
E03	The value is over the upper limit .
E04	The original data error result in this error (pH & Cond).
E12	Factory calibration data error (pH). Solution: Re-start meter might solve this error.
E13	Slop or offset value of pH probe is out of the range.
E16	Factory calibration data error (Cond.). Solution: Re-start meter might solve this error.
E17	Cell constant of Cond. probe is out of the range. Solution: Re-start meter might solve this error.
E31	Measuring circuit failure. Solution: Re-start meter might solve this error.
E32	Memory IC failure.

PC CONNECTION

The meter can link with a personal PC to capture on-line or stored data. You can retrieve file, save the data for further analysis check record statisticsEtc.

CONNECTION PROCEDURES:

1. Plug RS232 cable onto the RS232 jack port at the rear side of the meter.
2. Insert the D-sub 9P type connector onto computer's COM port (COM1~COM8).
3. Start to set up RS232 software by inserting the CD-ROM.
4. When installing the RS232 software, please follow the procedure of operation manual in the software CD.

PROTOCOL:

1. RS232 cable: 9600 bps, 8 data bits, no parity.
2. Format in Normal mode: (Transmitting ASCII code every second.)

1)Normal data:

pxx.xxpH:mxx.xxmV: Cxxxx(xx.xx, xxx.x)mS(uS) : Dxxxx(xx.xx, xxx.x)ppm(ppt) : Sxx.xxppt:Txxx.xC(F):Txxx.xC(F) @2007-04-18 18:48:48LRCCRLF

2)When error occurs:

ExxNul:ExxNul:ExxNul:ExxNul:ExxNul:ExxNul:ExxNul @2007-04-18 18:48:48LRCCRLF

3)Description: \$pH:mV:Cond:TDS:Salt:TpH:Tcon LRC CRLF

Note:

The 1st value is pH reading in pH, 2nd value is Voltage reading in mV, 3rd value is Conductivity in mS/uS, 4th value is TDS in ppm/ppt, 5th value is SALT in ppt, 6th value is Temp. of pH probe in C/F, 7th value is Temp. of Cond probe in C/F. The x means one of {0|1|2|...|9|-}

3. Format in Memory transmit mode (pH memory)

1)Normal data: pxx.xxpH: Txxx.xC(F) #xx @2007-04-18 18:48:48LRCCRLF

2)When error occurs: ExxNul: ExxNul #xx @2007-04-18 18:48:48LRCCRLF

3)Description: \$pH: Temp LRC CRLF

4. Format in Memory transmit mode (mV memory)

1)Normal data: mxx.xxmV: Txxx.xC(F) #xx @2007-04-18 18:48:48LRCCRLF

2)When error occurs: ExxNul:ExxNul #xx @2007-04-18 18:48:48LRCCRLF

3)Description: \$mV:Temp LRC CRLF

5. Format in Memory transmit mode (Cond. memory)

1)Normal data:

Cxxxx(xx.xx, xxx.x)mS(uS) :Txxx.xC(F) #xx @2007-04-18 18:48:48LRCCRLF

2)When error occurs: ExxNul:ExxNul #xx @2007-04-18 18:48:48LRCCRLF

3)Description: \$Cond:Temp LRC CRLF

6. Format in Memory transmit mode (TDS memory)

1) Normal data:

Dxxx(xx.xx, xxx.x)ppm(ppt) :Txxx.xC(F) #xx @2007-04-18 18:48:48LRCCRLF

2) When error occurs: ExxNul:ExxNul #xx @2007-04-18 18:48:48LRCCRLF

3) Description: \$TDS:Temp LRC CRLF

7. Format in Memory transmit mode (Salt memory)

1) Normal data:

Sxx.x(xx.xx) ppt :Txxx.xC(F) #xx @2007-04-18 18:48:48LRCCRLF

2) When error occurs: ExxNul:ExxNul #xx @2007-04-18 18:48:48LRCCRLF

3) Description: \$Salt:Temp LRC CRLF

APPENDIX: COND. & TDS CONVERSION FACTOR

Appendix A: Conductivity to TDS Conversion Factors

Conductivity at 25 °C	TDS Kcl		TDS NaCl		TDS 442	
	ppm value	Factor	ppm value	Factor	ppm value	Factor
1413 μ S	744.7	0.527	702.1	0.4969	1000	0.7078
2070 μ S	1045	0.5048	1041	0.5029	1500	0.7246
2764 μ S	1382	0.5	1414.8	0.5119	2062.7	0.7463
8974 μ S	5101	0.5685	4487	0.5	7608	0.8478
12,880 μ S	7447	0.5782	7230	0.5613	11,367	0.8825
15,000 μ S	8759	0.5839	8532	0.5688	13,455	0.897
80mS	52,168	0.6521	48,384	0.6048	79,688	0.9961

442 stands for:
40% sodium sulfate,
40% sodium bicarbonate
& 20% sodium chloride.

Appendix B: Calculate TDS conversion factors

The meter can be calibrated by using TDS calibration standard solutions. The calibration standard requires the TDS value at a standard temperature such as 25°C. To determine the conductivity-to-TDS conversion factor, please use the following formula:
Factor = Actual TDS/Actual Conductivity at 25°C

Definitions:

Actual TDS: Value from the solution bottle label or from a standard buffer which made by using high purity water and precisely weighed salts.

Actual Conductivity: Value measured using a properly calibrated Conductivity/TDS/ Temperature meter.

The **actual TDS** unit is associated with the unit of **actual conductivity values**. For example, if the TDS value is ppm, the conductivity value must be in μ S; if the TDS value is in ppt, the conductivity value must be in mS.

Check this number by multiplying the conductivity reading by the factor in the above formula and the result is the TDS in ppm.

Appendix C: Temperature effect

Conductivity measurements are temperature dependent, if the temperature increases, conductivity increases. eg: the conductivity measured in a 0.01 M KCl solution at 20°C is 1.273 mS/cm, whereas, at 25°C, it is 1.409 mS/cm

The concept of reference temperature (Normalization temperature) was introduced to allow the comparison of conductivity results obtained at different temperature. The reference temperature is usually 20°C or 25°C. The conductivity meter measures the actual **COND.** and temperature. Then converts it to the reference temperature using a temperature correction function and displays the conductivity at the reference temp.. It is mandatory to always associate the temperature together with a conductivity result. If no temperature correction is applied, the conductivity is the value taken at measurement temperature.

Linear temperature correction:

In moderately and highly conductive solutions, temperature correction can be based on a linear equation involving a temperature coefficient (θ). The coefficient is usually expressed as a conductivity variation in %/°C. Linear temperature correction is used, e.g. for saline, acids and leaching solutions.

where:
$$K_{Tref} = \frac{100}{100 + \theta \cdot (T - T_{ref})} \cdot K_T$$

K_{Tref} = Conductivity at Tref

K_T = Conductivity at T (While T_c in P5.2 is set as 0.0, the measured conductivity is K_T)

T_{ref} = Reference temperature

T = Sample temperature

θ = Temperature coefficient

NOTE:

The correction is accurate only within a limited temperature range around T_1 and T_2 .

The greater difference between T and T_{ref} , the higher risk of error.

Calculating Temperature Coefficients (θ)

By measuring the conductivity of a sample at temperature T_1 close to T_{ref} and another temperature T_2 , you can calculate the temperature coefficient by using the following equation:

$$\theta = \frac{(K_{T2} - K_{T1}) \cdot 100}{(T_2 - T_1) \cdot K_{T1}}$$

T_2 should be selected as a typical sample temperature and should be approximately 10°C different from T_1 . The temperature coefficients of the following electrolytes generally fall into the ranges shown below:

Acids: 1.0 - 1.6%/°C

Bases: 1.8 - 2.2%/°C

Salts: 2.2 - 3.0%/°C

Drinking water: 2.0%/°C

Ultrapure water: 5.2%/°C

Temp. Range °C	KCL 1M	KCL 0.1M	KCL 0.01M	Saturated NaCl
15-25	1.725	1.863	1.882	1.981
15-25-35	1.730 (15-27°C)	1.903	1.937 (15-34°C)	2.041
25-35	1.762 (25-27°C)	1.978	1.997 (25-34°C)	2.101

Average temperature coefficients of standard electrolyte solutions expressed as %/°C of the conductivity value at 25°C

Appendix D: Temperature effect on pH NIST Buffer

	0°C	5°C	10°C	15°C	20°C	25°C	30°C	35°C	40°C	45°C	50°C
PH 1.68	1.67	1.67	1.67	1.67	1.68	1.68	1.69	1.69	1.70	1.70	1.71
PH 4.01	4.01	4.01	4.00	4.00	4.00	4.01	4.01	4.02	4.03	4.04	4.06
PH 6.86	6.98	6.95	6.92	6.90	6.88	6.86	6.85	6.84	6.84	6.83	6.83
PH 9.18	9.47	9.38	9.32	9.27	9.22	9.18	9.14	9.10	9.07	9.04	9.01
PH 12.45	13.43	13.21	13.00	12.81	12.63	12.45	12.29	12.13	11.99	11.84	11.70

PRINTING

Printing function is designed in model 86551/552/553/554/555.

PRINTING KEYPAD

There are three function keys: PRINT, CONTRAST and FEED right under the printing device.

PRINT – Press to print out LCD displayed values.

CONTRAST – Press to adjust the printing deepness. (1~5 levels)

FEED – Press to feed paper into printer head.

FEEDING

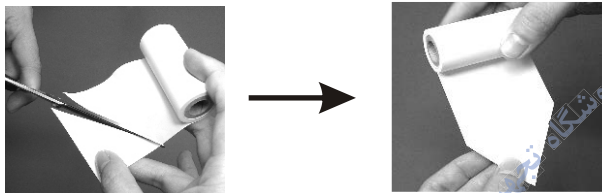

Open the printer cover, insert the sharp-cut paper to the cartridge of the printer, press **FEED** key to help you feed the paper.

CONTRAST

Press to adjust the printing deepness as you desired. After pressing, the printer will print automatically to demonstrate the printing deepness. There are 5 levels, **1** is the lightest and **5** is the darkest. Press **CONTRAST** key to select the printing contrast before printing.



PRINT

The displayed values and the stored memory both could be printed out by this printer. When print the displayed values, strongly suggest to hold the value first and then press key to print it out.

TO PRINT DISPLAYED VALUES:

Press  key to print out values which are displayed on the LCD, including: solution value, temperature and time. Strongly suggest to hold the value first and then press key to print it out.

TO PRINT STORED MEMORIES:

Press  key to select the mode of the stored memories you want to print out. Then, press  key to enter setting mode and enter program **P1.0**.

Now "ت" icon appears on the upper LCD and the **P1.0** shows on the lower LCD. At **P1.0**, press  key to enter **P1.1**. "out" icon will appear on the upper LCD and the **P1.1** shows on the lower LCD. "out" icon flash means the memory is under transmitting and the printer will automatically start to print.

EXAMPLE

Contrast testing:



Print Contrast: 2 of 5

Single point printing:

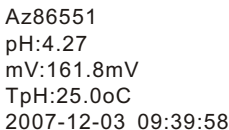

Az86551
pH:4.27
mV:161.8mV
TpH:25.0oC
2007-12-03 09:39:58

Memory printing:

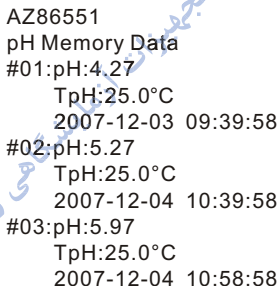

AZ86551
pH Memory Data
#01:pH:4.27
TpH:25.0°C
2007-12-03 09:39:58
#02:pH:5.27
TpH:25.0°C
2007-12-04 10:39:58
#03:pH:5.97
TpH:25.0°C
2007-12-04 10:58:58

SPECIFICATION

MODEL	PROBE	PH	mV/ORP(mV)	Cond.	TDS	Salinity
86501/551	PH	●	●			
86502/552	PH ORP	●	●			
86503/553	Cond.			●		
86504/554	PH Cond. ORP	●	●		●	
86505/555	PH Cond. ORP	●	●		●	●

Measure Item	pH	ORP	Conductivity	TDS	SALT
Range	0.00 to 14.00 pH	-1999 to +1999 mV	0 to 19.99 uS 0 to 199.9 uS 0 to 1999 uS 0 to 19.99 mS 0 to 199.9 mS	0 to (19.99 ^f) ppm 0 to (199.9 ^f) ppm 0 to (1999 ^f) ppm 0 to (19.99 ^f) ppt 0 to (199.9 ^f) ppt f.TDS conversion factor	0 to 11.38 ppt 0 to 80.0 ppt (NaCl)
Resolution	0.01 pH	0.1 mV (-199.9 to +199.9mV) 1 mV (othe rs)	0.01 uS 0.1 uS 1 uS 0.01 mS 0.1 mS	0.01 ppm 0.1 ppm 1 ppm 0.01 ppt 0.1 ppt	0.1 ppt
Accuracy	±0.02 pH	±0.02 mV (-199.9 to +199.9mV) ±2 mV (othe rs)	± (1% FS + digit)	± (1% FS + digit)	± (1% FS + digit)
ATC or MTC	Yes		Yes	Yes	Yes
Calibration	Max. 5 points automatic Buffer recognition		Max. 5 points (one point per range)	1.Max. 5 points (one point per range) 2.Adjust TDS conversion factor	Max. 2 points (one point per range)
Calibration acceptable window	NIST: ±1.25 at 6.86 ±1.00 (others) CUST:±1.00		±20% of the factory default value and ≥ 10%FS	±20% of the factory default value and ≥ 10%FS	
pH Slope / Offset display	Yes				
Slope Alarm	Out of 75% to 115%				
Offset Alarm	Out of ±60 mV				
Conductivity cell constant			1.0		
Conductivity Temperature Coefficient (Tc)			0.0% to 10.0% /°C		
Reference Temp. (Tref)			Factory set at 25 °C		
TDS conversion factor				0.300~1.000	Non-linear Compensation

- Operation temperature: 5~40°C
- Operation RH%: up to 95% without condensation
- Storage Temperature: -20~60°C
- Storage RH%: up to 95% without condensation
- Size: 86501~86505:217x168x58mm (LxWxT)
86551~86555:260x168x58mm (LxWxT)
- Weight: 86501~86505:Approx. 137g (meter only)
86551~86555:Approx. 150g (meter only)
- Thermo paper roll: 57mm x 20M x 40@

- Conductivity Default Preferences (display "Con" words)

Program	Preference	Default	Display content	Remark
P1.0	Memory transmitting	No default	"Er"	Follow Cond. or TDS of Normal mode.
P1.1	MEM sent by RS232		"out"	
P2.0	MEM clear	Always defaults "no"	"CLR"	Follow Cond. or TDS of Normal mode.
P2.1	CLR confirm		"YES" or "no"	
P3.0	CAL View		"CAL"	Ra1~Ra5
P3.1~3.5	Cal solution value	14.13uS, 141.3uS, 1413uS 14.13mS, 141.3mS	Cond/TDS/SALT solution value	
P4.0	CELL		"CELL"	Ra1~Ra5
P4.1~4.5	Constant	1.000		
P5.0	Temp setting		"DEF"	
P5.1	ATC/MTC	ATC	"Auto" or "NaN"	
P5.2	Temp. Coefficient	2.1%		0.0% ~ 10.0%
P5.3	MTC	25°C		
P5.4	TDS Factor	0.500		0.300~1.000
P6.0	Ready function		"rdy"	
P6.1	Enable or disable it	"YES"	"YES" or "no"	
P7.0	Temp unit		"U"	
P7.1	Select C or F	"C"	"C" or "F"	
P8.0	Real time clock		"rtc"	
P8.1~8.6	Setting YMD,HMS	No default	"rtc"	
P9.0	RESET		"rst"	Cond/TDS/SALT reset
P9.1	Reset confirm	Always defaults "no"	"YES" or "no"	

- pH/mv Default Preferences (display " pH" words)

Program	Preference	Default	Display content	Remark
P1.0	Memory transmitting	No default	"E"	Follow pH or mV of Normal mode.
P1.1	MEM sent by RS232		"out"	
P2.0	MEM clear	Always defaults "no"	"CLR"	Follow pH or mV of Normal mode.
P2.1	CLR confirm		"YES" or "no"	
P3.0	Electrode		"ELE"	
P3.1~3.4	Slope	100.0%	Slope value	
P3.5	Offset	0.0mV	Offset value	
P4.0	Buffer solution		"buf"	
P4.1	Select buffer	"NIST"	"NIST" or "CUST"	
P6.0	Ready function		"rdy"	
P6.1	Enable or disable it	"YES"	"YES" or "no"	
P7.0	Temp unit		"U"	
P7.1	Select C or F	"C"	"C" or "F"	
P8.0	Real time clock		"rtc"	
P8.1~8.6	Setting YMD,HMS	No default	"rtc"	
P9.0	RESET		"rst"	PH / mV reset
P9.1	Reset confirm	Always defaults "no"	"YES" or "no"	

WARRANTY

The meter is warranted to be free from defects in material and workmanship for a period of one year from the date of purchase. This warranty covers normal operation and does not cover battery, misuse, abuse, alteration, tampering, neglect, improper maintenance or damage resulting from leaking batteries.

Proof of purchase is required for warranty repairs. Warranty is void if the meter has been opened.

RETURN AUTHORIZATION

Authorization must be obtained from the supplier before returning items for any reason. When requiring a RA (Return Authorization), please include data regarding the defective reason, the meters are returned along with good packing to prevent any damage in shipment and insured against possible damage or loss.

Accuracy, the Zenith of
Measuring / Testing Instruments !

Hygrometer/Psychrometer
Thermometer
Anemometer
Sound Level Meter
Air Flow meter
Infrared Thermometer
K type Thermometer
K.J.T. type Thermometer
K.J.T.R.S.E. type Thermometer
pH Meter
Conductivity Meter
T.D.S. Meter
D.O. Meter
Saccharimeter
Manometer
Tacho Meter
Lux / Light Meter
Moisture Meter
Data logger
Temp./RH transmitter
Wireless Transmitter

More products available !

2013.08.Ver.4