

### Instruction Manual 731 005/Rev G/05-17

فروشگاه تجهیزات آزمایشگاهی روناکو

## Safety

Please read this information carefully prior to installing or using this equipment.

1. The unit described in this manual is designed to be operated only by trained personnel. Any adjustments, maintenance and repair must be carried out as defined in this manual, by a person qualified to be aware of the hazards involved.
2. It is essential that both operating and service personnel employ a safe system of work, in addition to the detailed instructions specified in this manual.
3. Other than for those items defined in the maintenance procedures herein there are no user serviceable items in this instrument. Removal of covers and attempted adjustment or service by unqualified personnel will invalidate the warranty and may incur additional charges for repair.
4. References should always be made to the Health and Safety data supplied with any chemicals used. Generally accepted laboratory procedures for safe handling of chemicals should be employed. Do not use hazardous or flammable substances in the instrument.
5. If it is suspected that safety protection has been impaired in any way, the unit must be made inoperative and secured against any intended operation. The fault condition should immediately be reported to the appropriate servicing authority.
6. The warning symbol alerts the user to important information about using the instrument. Read and follow the associated instructions carefully.



7. This instrument uses a UV light source. Do not look directly at the light source.



8. WARNING: If the equipment is not used in the manner specified, the protection provided by the equipment may be impaired.
9. Do not replace the detachable mains leads with inadequately rated leads.

**Merci de lire attentivement ces informations avant d'installer ou d'utiliser cet appareil.**

1. L'appareil décrit dans ce manuel est conçu pour être utilisé uniquement par des personnes formées. Tout réglage, maintenance ou réparation doit être effectué comme décrit dans ce manuel, par une personne qualifiée consciente des risques encourus.
2. Il est essentiel que les personnes utilisant et intervenant sur cet appareil respectent les règles de sécurité de travail, en plus des instructions détaillées précisées dans ce manuel.
3. En-dehors des éléments décrits dans les procédures de maintenance ci-incluses, cet appareil ne contient aucun élément réparable par l'utilisateur. L'enlèvement des capots et les tentatives de réglage ou de réparation par des personnes non qualifiées invalide toute garantie et entraîne un risque de frais de réparation supplémentaires.
4. Toujours se référer aux fiches techniques de santé et de sécurité accompagnant tout produit chimique utilisé. Respecter les procédures de laboratoire généralement acceptées pour la manipulation en toute sécurité des produits chimiques. Ne pas utiliser de substances dangereuses ou inflammables sur l'appareil.
5. Si l'utilisateur suspecte qu'un problème quelconque puisse mettre en cause la sécurité, l'appareil doit être rendu inopérant en empêchant son utilisation. Communiquer la défaillance constatée au service de maintenance compétent.
6. Le symbole d'alerte signale à l'utilisateur les informations importantes concernant l'utilisation de l'appareil. Lire et suivre les instructions fournies avec la plus grande attention.



7. Cet appareil utilise une source lumineuse UV. Ne pas regarder directement vers la source.



8. ATTENTION. Si l'appareil n'est pas utilisé de manière adéquate, la protection de l'appareil pourrait être impactée.
9. Ne pas remplacer le cordon d'alimentation fourni par un cordon d'alimentation de dimension électrique non adapté.

فروشگاه تجهیزات آزمایشگاهی روناکو

**Bitte lesen Sie diese Hinweise vor Installation oder Gebrauch dieser Ausrüstung sorgfältig durch.**

1. Das in diesem Handbuch beschriebene Gerät darf nur von geschultem Personal bedient werden. Alle Anpassungen, Wartungsarbeiten und Reparaturen müssen entsprechend der Vorgaben in diesem Handbuch und von einer kompetenten Person, die mit den damit verbundenen Gefahren vertraut ist, durchgeführt werden.
2. Es ist wichtig, dass sowohl das Bedienungs- als auch das Service-Personal zusätzlich zu den detaillierten Anweisungen in diesem Handbuch ein sicheres Arbeitssystem einsetzen.
3. Mit Ausnahme der Teile, deren Wartungsverfahren in diesem Handbuch beschrieben sind, enthält dieses Gerät keine weiteren Teile, die vom Benutzer gewartet werden können. Das Entfernen von Abdeckungen und Versuche von hierfür unqualifiziertem Personal, Anpassungen oder Wartungsarbeiten durchzuführen, haben zur Folge, dass die Garantie verfällt und können zusätzliche Reparaturkosten auslösen.
4. Es ist jederzeit auf die sicherheitsrelevanten Daten sämtlicher verwendeter Chemikalien Bezug zu nehmen. Allgemein anerkannte Labormethoden zum sicheren Umgang mit Chemikalien sollten eingesetzt werden. Verwenden Sie keine gefährlichen oder entzündlichen Stoffe in Verbindung mit dem Gerät.
5. Besteht der Verdacht, dass die Sicherheitsvorrichtungen in irgendeiner Weise beschädigt wurden, muss das Gerät außer Betrieb genommen und gegen weiteren Gebrauch gesichert werden. Die Störung sollte der zuständigen Serviceeinrichtung unverzüglich gemeldet werden.
6. Das Warnsymbol weist auf wichtige Informationen zur Verwendung des Geräts hin. Lesen und befolgen Sie die dazugehörigen Anweisungen sorgfältig.



7. Dieses Instrument greift auf eine UV-Lichtquelle zurück. Nicht direkt in die Lichtquelle schauen.



8. ACHTUNG: Wenn das Gerät nicht in der vorgegebenen Weise eingesetzt wird, können die Schutzfunktionen des Gerätes beeinträchtigt werden.
9. Abnehmbares Anschlusskabel nicht durch unangemessen bewertete Kabel austauschen.

**Leggere attentamente queste istruzioni prima di installare o utilizzare il dispositivo.**

1. L'unità descritta nel presente manuale è stata realizzata per essere utilizzata solo da personale che ha ricevuto l'apposita formazione. Qualsiasi operazione di regolazione, manutenzione e riparazione deve essere effettuata sulla base di quanto indicato nel presente manuale da personale qualificato consapevole dei rischi connessi.
2. È fondamentale che il personale operativo e il personale addetto alla manutenzione utilizzino un sistema di lavoro sicuro, oltre a seguire le istruzioni specificate nel presente manuale.
3. Oltre a quelli indicati nelle procedure di manutenzione, all'interno di questo dispositivo non sono presenti altri elementi sui quali è possibile effettuare interventi. La rimozione delle protezioni e qualsiasi tentativo di regolazione o di manutenzione posto in essere da personale non qualificato invaliderà la garanzia. In questi casi, sarà necessario pagare un importo per le riparazioni effettuate.
4. È sempre necessario fare riferimento ai dati sulla salute e sulla sicurezza forniti con le sostanze chimiche utilizzate. Adottare le procedure di laboratorio generalmente accettate per la gestione delle sostanze chimiche. Non utilizzare sostanze pericolose o infiammabili sullo strumento.
5. Nel caso in cui si sospetti che la salute possa essere pregiudicata in qualsiasi modo, disattivare l'unità per renderla inutilizzabile. Qualsiasi condizione di errore deve essere immediatamente segnalata al responsabile per la manutenzione.
6. Il simbolo di avvertenza informa l'utente sulle informazioni importanti in merito all'uso dello strumento. Leggere e seguire le istruzioni corrispondenti con cura.



7. Questo strumento utilizza una sorgente di luce UV. Non guardare direttamente la sorgente di luce.



8. **AVVERTENZA:** qualora il dispositivo non venga utilizzato nel modo descritto, la protezione fornita dal dispositivo stesso potrebbe risultare compromessa.
9. Non sostituire i cavi di alimentazione di rete scollegabili con cavi inadeguati.

**Lea esta información atentamente antes de instalar o utilizar este equipo.**

1. La unidad descrita en este manual está diseñada para que solamente la utilice personal con formación. Cualquier operación de ajuste, mantenimiento y reparación debe llevarse a cabo del modo indicado en este manual y debe realizarla una persona cualificada que sea consciente de los peligros que implica.
2. Es fundamental que tanto los operarios como el personal de servicio utilicen un sistema de trabajo seguro, así como las instrucciones detalladas que se especifican en este manual.
3. Cualquier elemento que no se encuentre entre los definidos en los procedimientos de mantenimiento aquí descritos no podrá utilizarse en este instrumento. La extracción de las tapas y los intentos de ajuste o reparación por parte de personal no cualificado invalidarán la garantía y pueden incurrir en cargos adicionales por reparación.
4. Siempre deberían consultarse los datos sobre Salud y Seguridad que se suministran con cualquier producto químico que se utilice. Es necesario llevar a cabo los procedimientos de laboratorio de aceptación generalizada para la manipulación segura de productos químicos. No utilice sustancias peligrosas o inflamables en el instrumento.
5. Si existe la sospecha de que las medidas protectoras de seguridad han quedado dañadas en cualquier modo, la unidad debe inutilizarse y protegerse contra toda operación que se intente llevar a cabo. El estado de fallo debe comunicarse inmediatamente a la autoridad de servicio de mantenimiento y reparación pertinente.
6. El símbolo de advertencia avisa al usuario de información importante relacionada con el uso del instrumento. Lea atentamente y siga las instrucciones correspondientes.



7. Este instrumento utiliza una fuente de luz UV. No mire directamente a la fuente de luz.



8. ADVERTENCIA: Si el equipo no se utiliza de la manera especificada, la protección que ofrece el aparato puede verse afectada.
9. No sustituya el cable de alimentación eléctrica con cables de voltaje inadecuado.

## Contents

Safety .....	
SECTION 1 – Introduction.....	10
1.1 INSTRUMENT DESCRIPTION.....	10
1.2 IMPORTANT SAFETY ADVICE.....	11
1.3 INSTRUMENT SPECIFICATION.....	12
SECTION 2 – Installation .....	13
2.1 UNPACKING.....	13
2.2 INSTALLATION .....	13
2.3 DISPLAY .....	14
2.4 CONTROLS.....	15
2.5 REAR PANEL.....	16
2.6 FRONT PANEL.....	16
SECTION 3 – Theory and Practice of Spectroscopy Measurements .....	17
3.1 THEORY OF SPECTROSCOPY MEASUREMENT .....	17
3.2 SPECTROSCOPY MEASUREMENT .....	18
3.3 GOOD PRACTICE GUIDELINES.....	19
SECTION 4 – Instrument Setup .....	21
4.1 NAVIGATING AND SCREEN SETUP .....	21
4.2 TIME AND DATE .....	22
4.3 INSTRUMENT SETTINGS MENU.....	23
4.4 SECURITY AND SETTING PASSWORDS.....	23
4.4.1 Setting Security Codes .....	23
4.4.2 Settings lock.....	24
4.4.3 Method Lock .....	24
4.5 MODE SELECTION.....	25
4.6 GLP SETTINGS.....	25
4.7 SCREEN CONTRAST .....	26
4.8 LAMP SAVE.....	26
SECTION 5 – PHOTOMETRICS .....	28
5.1 MODE SPECIFIC PARAMETERS .....	28
5.2 METHOD SET UP .....	28
5.2.1 Selecting a Wavelength .....	28
5.3 CALIBRATION.....	29
5.4 SAMPLE MEASUREMENT.....	29
SECTION 6 – CONCENTRATION .....	30
6.1 MODE SPECIFIC PARAMETERS .....	30
6.2 METHOD SETUP .....	30
6.2.1 Selecting a Wavelength .....	30
6.2.2 Settings .....	31
6.2.2.1 Selecting Concentration Units .....	31
6.2.2.2 Changing the Resolution .....	32
6.2.2.3 Using a Standard .....	32
6.2.2.4 Using a Factor .....	32
6.3 CALIBRATION.....	33
6.3.1 Calibrating to a Standard .....	33
6.3.2 Calibrating to a Factor .....	34
6.4 SAMPLE MEASUREMENT .....	34
6.4.1 Measuring a Sample After Calibrating to a Standard .....	34
6.4.2 Measuring a Sample After Calibrating to a Factor .....	34

6.5	POST MEASUREMENT OPTIONS.....	34
6.5.1	Changing Concentration Units.....	35
6.5.2	Changing the Concentration Factor.....	36
6.5.3	Changing the Calibration Standard Value.....	36
<b>SECTION 7 – SPECTRUM.....</b>		<b>37</b>
7.1	MODE SPECIFIC PARAMETERS.....	37
7.2	METHOD SETUP.....	37
7.2.1	Scan Settings.....	38
7.2.2	Selecting Absorbance or % Transmittance.....	38
7.2.3	Setting Start and End Wavelengths.....	38
7.2.4	Setting the Scan Interval.....	39
7.2.5	Y-Axis Scaling.....	39
7.3	CALIBRATION.....	40
7.4	SAMPLE MEASUREMENT.....	41
7.5	DATA ANALYSIS.....	42
7.5.1	Peaks and Valleys Threshold.....	42
7.5.2	Peaks and Valleys Table.....	43
7.5.3	Spectral Points Analysis.....	43
<b>SECTION 8 – QUANTITATION.....</b>		<b>46</b>
8.1	MODE SPECIFIC PARAMETERS.....	46
8.2	METHOD SETUP.....	47
8.2.1	Selecting a Wavelength.....	47
8.2.2	Selecting Number of Standards.....	47
8.2.3	Selecting Concentration Units.....	48
8.2.4	Changing the Resolution.....	48
8.2.5	Selecting Absorbance or % Transmittance.....	48
8.3	Quantitation Table.....	48
8.3.1	Modifying Standards.....	49
8.4	STANDARD CURVE.....	50
8.4.1	Creating a New Standard Curve.....	50
8.5	CALIBRATION.....	52
8.6	SAMPLE MEASUREMENT.....	52
8.7	DATA ANALYSIS.....	52
8.8	POST MEASUREMENT OPTIONS.....	53
8.8.1	Changing Concentration Units.....	53
8.8.2	Changing the Quantitation Table Values.....	54
<b>SECTION 9 – KINETICS.....</b>		<b>55</b>
9.1	MODE SPECIFIC PARAMETERS.....	55
9.2	METHOD SET UP.....	56
9.2.1	Kinetics Settings.....	56
9.2.1.1	Y-Axis Scaling.....	56
9.2.1.2	Setting Lag Time or Start on Level.....	57
9.2.1.3	Selecting Absorbance or % Transmittance.....	58
9.2.1.4	Changing the Resolution.....	58
9.2.1.5	Selecting Concentration Units.....	58
9.2.1.6	Using a Standard.....	59
9.2.1.7	Using a Factor.....	59
9.2.1.8	Selecting a Wavelength.....	60
9.2.1.9	Setting the Kinetics Measurement Time.....	60
9.3	CALIBRATION.....	60
9.4	SAMPLE MEASUREMENT.....	61
9.5	DATA ANALYSIS.....	61
9.6	POST MEASUREMENT OPTIONS.....	63
9.6.1	Changing Concentration Units.....	63
9.6.2	Changing the Concentration Factor.....	65
9.6.3	Changing the Calibration Standard Value.....	65



SECTION 10 – SAVING, PRINTING AND AUTOLOGGING.....	66
10.1 SAVING METHODS .....	66
10.1.1 SAVING METHODS TO INTERNAL MEMORY .....	66
10.1.2 SAVING METHODS TO USB MEMORY STICK.....	67
10.2 OPENING METHODS .....	68
10.2.1 OPENING METHODS FROM INTERNAL MEMORY .....	68
10.2.2 OPENING METHODS FROM USB MEMORY STICK .....	68
10.3 DELETING METHODS.....	69
10.4 SAVING RESULTS.....	69
10.5 OPENING RESULTS.....	71
10.6 DELETING RESULTS .....	71
10.7 PRINTING.....	72
10.7.1 Print Setup .....	72
10.7.1.1 Print Setup – PHOTOMETRICS AND CONCENTRATION .....	73
10.7.1.2 Print Setup - SPECTRUM .....	73
10.7.1.3 Print Setup – QUANTITATION.....	73
10.7.1.4 Print Setup – KINETICS .....	74
10.7.2 Printing Results.....	74
10.8 AUTOLOGGING .....	75
10.8.1 Setting the Number of Sample Repetitions .....	75
10.8.2 Selecting Result’s Destination .....	77
10.9 CONNECTING TO A PC .....	77
SECTION 11 – Accessories and Spare Parts .....	78
11.1 OPTIONAL ACCESSORIES.....	78
11.2 CONNECTING THE ACCESSORIES .....	78
11.2.1 INTERNAL PRINTER .....	78
11.2.2 PASSIVE ACCESSORIES .....	79
11.2.3 ACTIVE ACCESSORIES .....	82
11.2.3.1 Automatic 8 cell turret.....	82
11.2.3.2 Peltier .....	83
11.2.3.3 Sipper pump .....	84
11.2.3.4 Combined sipper Peltier pump .....	87
11.3 USING THE ACCESSORIES .....	87
11.3.1 Automatic 8 cell turret.....	87
11.3.1.1 Automatic 8 cell turret – supporting creation of a standard curve in quantitation .....	87
11.3.2 Peltier.....	88
11.3.3 Sipper pump .....	89
11.3.3.1 Manual Sipper Pump Settings.....	89
11.3.3.2 Timed Sipper Pump Settings.....	90
11.3.4 Combined sipper Peltier pump .....	93
11.4 SPARES .....	93
SECTION 12 – Maintenance and Service .....	94
12.1 ROUTINE MAINTENANCE .....	94
12.2 LAMP REPLACEMENT .....	94
12.2.1 Tungsten Halogen Lamp Replacement.....	94
12.2.2 Xenon Lamp Module Replacement .....	94
12.3 SERVICE .....	95
SECTION 13 – Troubleshooting.....	96
13.1 ERROR CODES .....	96
13.2 TROUBLESHOOTING GUIDE .....	98
13.3 TECHNICAL SUPPORT .....	98
SECTION 14 – Declaration of Conformity .....	99
SECTION 15 – Glossary of Icons.....	100

## SECTION 1 – Introduction

### 1.1 INSTRUMENT DESCRIPTION

The 7310 and 7315 spectrophotometers are suited to a wide range of applications in education, quality control, environmental and clinical analysis. The 7310 is a visible spectrophotometer covering a wavelength range from 320nm to 1000nm. The 7315 is a UV/Visible spectrophotometer with a wavelength range from 198nm to 1000nm. Both models have five measurement modes: photometrics, concentration, spectrum scanning, quantitation and kinetics. These instruments use icon driven software and have an improved navigation system for easy and intuitive usability.

This equipment is designed to operate under the following conditions:

- ❖ For indoor use only
- ❖ Use in a well ventilated area
- ❖ Ambient temperature range 5°C to 40°C (41°F to 104°F)
- ❖ Altitude to 2000 m (6500 ft)
- ❖ Relative humidity not exceeding 80%
- ❖ Mains supply fluctuations not exceeding 10% of nominal
- ❖ Overvoltage category II IEC60364-4-443
- ❖ Pollution degree 2 IEC664
- ❖ Use with a minimum distance all round of 200 mm (8 in.) from walls or other items

If the equipment is not used in the manner described in this manual and with accessories other than those recommended by the manufacturer, the protection provided may be impaired.

فروشگاه تجهیزات آزمایشگاهی روناکو

## 1.2 IMPORTANT SAFETY ADVICE

- ❖ SHOCK HAZARDS OR UNSAFE PRACTICES ARE DANGEROUS as they can cause severe personal injury, fire or death.
- ❖ DO NOT use combustible substances near hot objects.
- ❖ DO NOT use the equipment in hazardous atmospheres.
- ❖ DO NOT operate or handle any part of the product with wet hands or use on surfaces that may become flooded.
- ❖ NEVER move the product while still connected to the power supply.
- ❖ HIGH TEMPERATURES ARE DANGEROUS as they can cause serious burns to operators and ignite combustible material.
- ❖ USE CARE AND WEAR PROTECTIVE GLOVES TO PROTECT HANDS.
- ❖ NEVER lift or carry the instrument until it has been switched off and allowed to cool.
- ❖ DO NOT position the unit so that it is difficult to disconnect from the mains supply using the mains plug.
- ❖ The mains outlet socket used should be located close to the equipment and readily identifiable and accessible to users.
- ❖ DO NOT leave equipment switched on and it is not recommended to leave any heating apparatus unattended during operation.
- ❖ The unit should be carried using both hands.

### SYMBOLS DEFINED



**CAUTION**

Refer to instructions



**HOT SURFACE**

فروشگاه تجهیزات آزمایشگاهی روناکو

### 1.3 INSTRUMENT SPECIFICATION

	7310	7315
<b>Wavelength</b>		
Range	320 to 1000nm	198 to 1000nm
Resolution	1nm	
Accuracy	± 2nm	
Repeatability	± 0.5nm	
Spectral bandwidth	5nm	
<b>Photometrics</b>		
Transmittance	0 to 199.9%	
Absorbance	-0.300 to 2.500A	
Accuracy	±1%T, ±0.01Abs at 1.000 Absorbance	
Resolution	0.1%T, 0.001A	
Stray light	<0.5% at 340nm	<0.5% at 340nm and 220nm
<b>Concentration</b>		
Range	-300 to 9999	
Resolution	Selectable 1/0.1/0.01/0.001	
Calibration	Blank with a single standard or factor	
Units	no units, %, ppm, EBC, SRM, mEq/l, mEq, M, mM, µM, nM, U, U/l, U/ml, g/l, mg/l, µg/l, ng/l, g/dl, mg/dl, µg/dl, mg/ml, µg/ml, ng/ml, µg/µl, ng/µl, mol/l, mmol/l	
Factor	0.001 to 10000	
Standard	0.001 to 1000	
<b>Quantitation</b>		
Range	-300 to 9999	
Resolution	Selectable 1/0.1/0.01/0.001	
Calibration	Blank with up to 6 standards	
Units	no units, %, ppm, EBC, SRM, mEq/l, mEq, M, mM, µM, nM, U, U/l, U/ml, g/l, mg/l, µg/l, ng/l, g/dl, mg/dl, µg/dl, mg/ml, µg/ml, ng/ml, µg/ul, ng/ul, mol/l, mmol/l	
Curve fit algorithms	Quadratic, quadratic through zero, linear, linear through zero, interpolate	
<b>Kinetics</b>		
Measurement Time	2 to 9999 seconds	
Calibration	Blank with a single standard or factor	
Display	Graphical and concentration	
Analysis	Concentration, rate of change, initial and final absorbance/%T	
Resolution	Selectable 1/0.1/0.01/0.001	
<b>Spectrum</b>		
Range	320 to 1000nm	198 to 1000nm
Scan interval	Selectable 1, 2 or 5nm	
Analysis	Absorbance or % transmittance and peak and valley wavelengths	
<b>Other</b>		
Beam height	15mm	
Light source	Tungsten halogen lamp	Xenon lamp
Lamp save	Yes	Not applicable
GLP	Current time and date, user ID, settings lock and method lock	
Number of users	999	
Methods memory	48 in each measurement mode	
Results memory	Limited by attached mass storage device	
Removable media	USB (supplied)	
Outputs	USB, Analogue, RS232, Internal printer	
Supply Voltage/ frequency	115 - 230VAC at 50 to 60Hz	
C put	24V DC, 2. A	
Size (w x d x h)	275 x 400 x 220mm	
Weight	6kg	

## SECTION 2 – Installation

### 2.1 UNPACKING

Remove the 7310 or 7315 from the packaging and ensure the following items are included:

Model 7310 spectrophotometer (731 001), or Model 7315 spectrophotometer (731 501)

24V 6 W power supply unit (021 060)

7310 - Pack of 100 disposable plastic visible wavelength cuvettes (060 084),

7315 - Pack of 100 disposable UV plastic cuvettes (060 230)

4GB USB memory stick (019 146)

Jenway 73 series PC software (735 100) and interface cable (013 203)

Instruction manual (731 005)

Jenway Foreign Manual CD (JENMANCD)

Optional accessories (as ordered)

### 2.2 INSTALLATION

Models 7310 and 7315 are supplied ready to use.

The unit should be placed on a clean flat surface which is free from drafts and vibrations. The units are designed for operation on 90V to 264V AC input at 47 to 63Hz. Select the correct plug attachment and attach to the power supply unit as shown below:

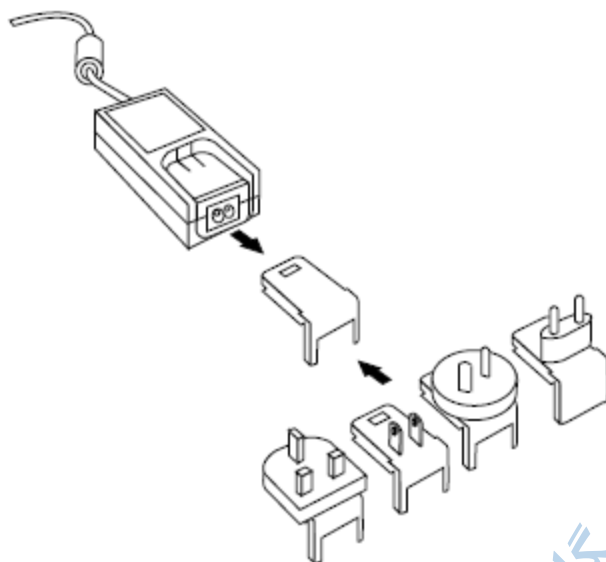
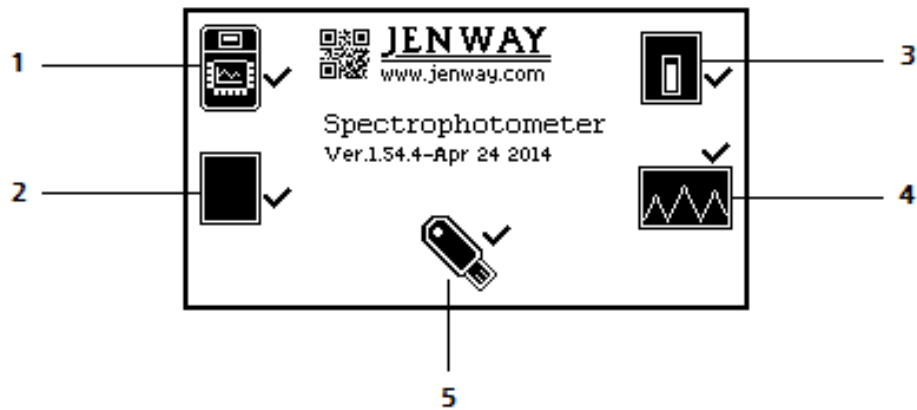

**Fig 2.2.1 – Power supply unit with various plugs**

فروشگاه تجهیزات آزمایشگاهی روناکو

Connect the power supply unit to the power inlet socket on the rear panel of the instrument and connect to the mains socket. Turn the power on at the mains and switch the instrument on using the power switch on the rear of the instrument.

The instrument will perform several power on tests before displaying the main menu:

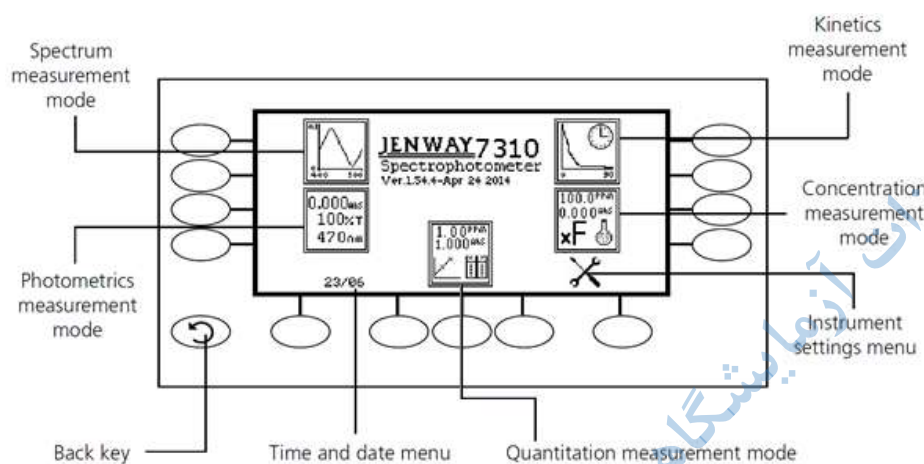

**Fig 2.2.2 – All Power On Tests Complete**

1. Instrument check – ensures the validity of the saved parameters
2. Dark test
3. Checks for the accessory fitted. If an active accessory is found the instrument verifies communication and response
4. Self-calibration of wavelengths
5. Checks communication between USB memory stick port and the instrument

### 2.3 DISPLAY

The instrument has a dot matrix display which enables icons and graphs to be displayed clearly. Following successful completion of the power on tests the main menu screen will be displayed:

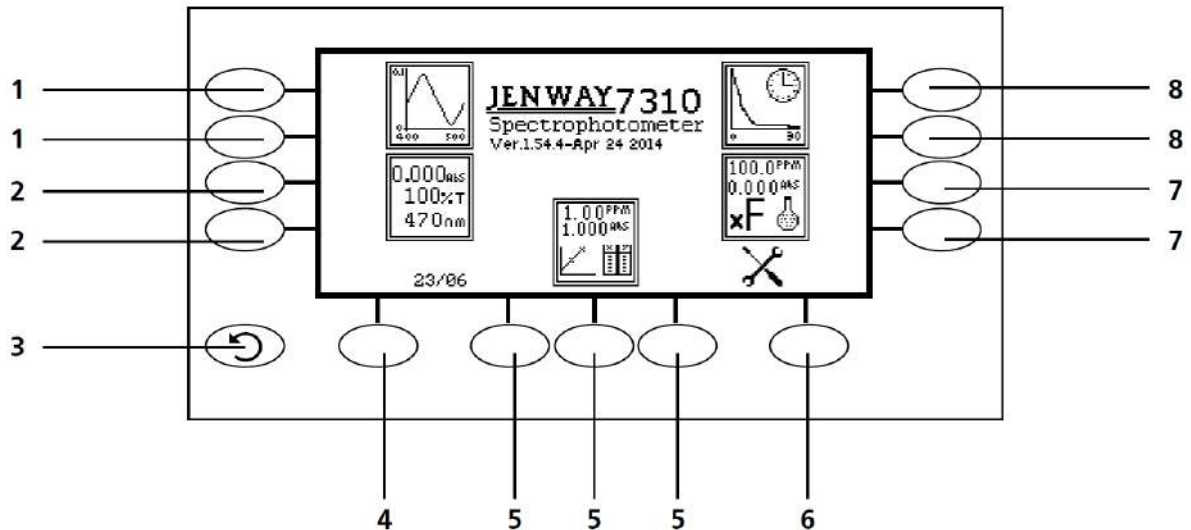

**Fig. 2.3 – Display**

## 2.4 CONTROLS

The keypad used for these models enables an easy and effective way of navigating the different measurement modes, entering numbers, saving and analysing results. The soft keys are active when an icon is displayed above or adjacent to the key. The only exception to this is the back key which is always active.

The main menu screen and surrounding keypad is displayed below.



**Fig. 2.4 – Display**

1. Spectrum measurement mode
2. Photometrics measurement mode
3. Back key
4. Time and date menu
5. Quantitation measurement mode
6. Instrument settings menu
7. Concentration measurement mode
8. Kinetics measurement mode

فروشگاه تجهیزات آزمایشگاهی روناکو

## 2.5 REAR PANEL

The image below shows the rear panel on the instrument:

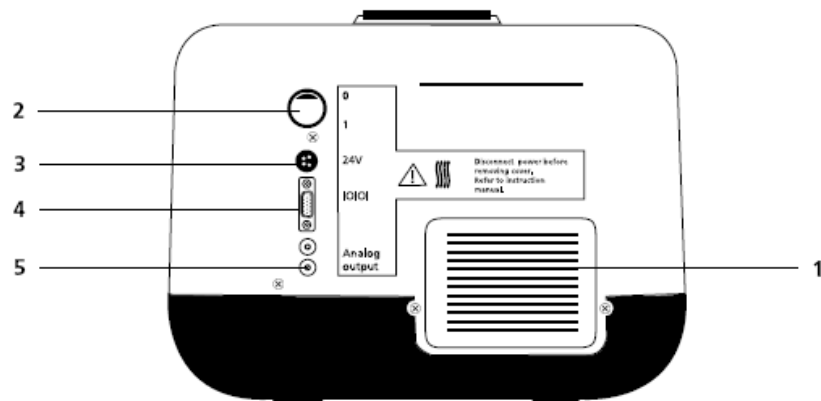
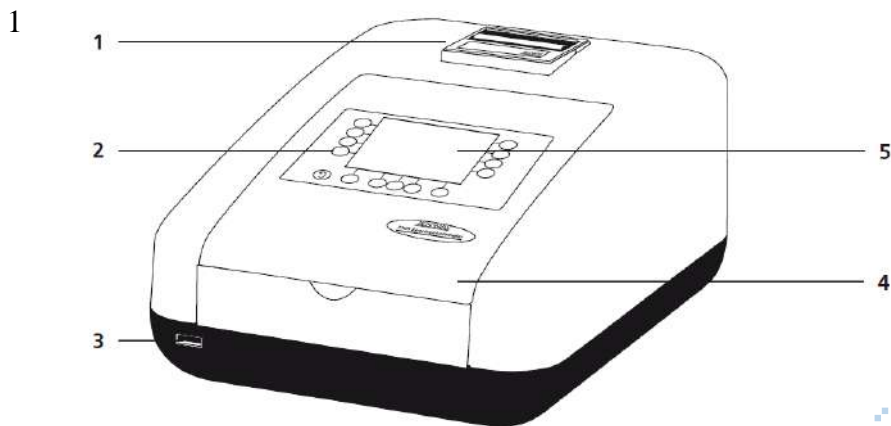

**Fig. 2.5 – Rear Panel**

- |                      |  |
|----------------------|--|
| 1. Lamp access panel | Allows access to tungsten lamp when replacement is necessary |
| 2. Power switch      | On/off switch for the unit                                   |
| 3. Power in socket   | Connection socket for power supply unit                      |
| 4. RS232 serial port | Connection to a PC or external serial printer                |
| 5. Output sockets    | Analogue output  |

## 2.6 FRONT PANEL

The image below shows the front panel of the instrument:



**Fig. 2.6 – Front Panel**

- |  |
|--|
| 1. Integral printer (optional accessory) |
| 2. Keypad                                |
| 3. USB memory stick slot                 |
| 4. Instrument lid                        |
| 5. Display                               |

فروشگاه تجهیزات آزمایشگاهی روناکو



## SECTION 3 – Theory and Practice of Spectroscopy Measurements

### 3.1 THEORY OF SPECTROSCOPY MEASUREMENT

UV-visible spectroscopy is the measurement of the absorbance of light at a specific wavelength in a sample. This is used to identify the presence and concentration of molecular entities within the sample. The Beer-Lambert law is used to relate the absorption of light to the properties of the sample through which the light is travelling through. The Beer-Lambert law states that:

$$A = \epsilon l c$$

- A** is the absorbance
- $\epsilon$**  is the molar absorption coefficient ( $l \text{ mol}^{-1} \text{ cm}^{-1}$ )
- c** is the concentration ( $\text{mol l}^{-1}$ )
- l** is the path length (cm)

This law shows that absorbance is linear to concentration but this is only true for low concentrations. For absorbance levels above 3 the concentration starts to move away from the linear relationship.

Transmittance is the proportion of the light which passes through the sample:

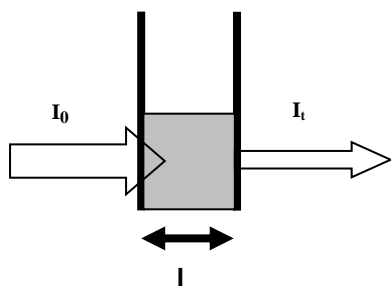

Where:

- $I_0$**  is the incident light
- $I_t$**  is the transmitted light
- l** is the path length

Therefore:

$$T = \frac{I_t}{I_0}$$

Absorbance is inversely related to transmittance:

$$A = \text{Log} \frac{1}{T}$$

فروشگاه تجهیزات آزمایشگاهی روناکو

### 3.2 SPECTROSCOPY MEASUREMENT

There are four main components of a spectrophotometer. These are a light source to emit a high and constant amount of energy over the full wavelength range; a method for separating the light into discrete wavelengths; a sample holder and a light detector.

The optical layout of the 7310 and 7315 spectrophotometers is shown below:

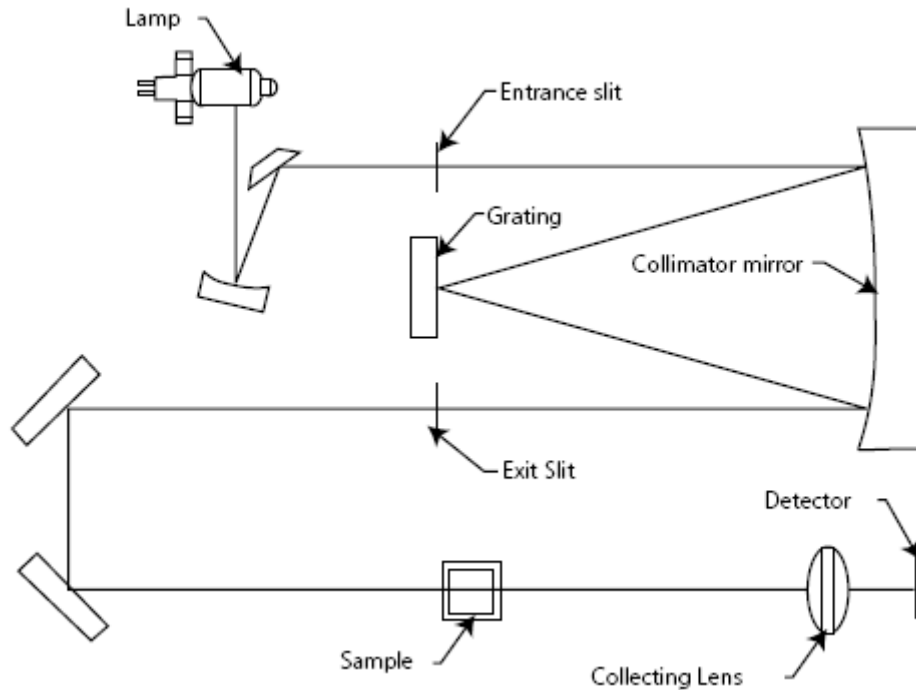

**Figure 3.2 – Diagram of light path**

The light from the pre-focused tungsten halogen (7310) or pre-aligned xenon (7315) lamp is focused onto the grating, with 1200 lines per millimeter, which separates the light into discrete wavelengths. The diffracted spectrum of light then passes through a further slit and lens arrangement before passing through the sample in the sample chamber from left to right. The light which is not absorbed by the sample is transmitted through a collecting lens and onto the signal detector. The photo-diode detector used is mounted directly onto the detector PCB and the output is used to calculate the % transmittance. The result is displayed either as % transmittance or absorbance on the instrument display.

### 3.3 GOOD PRACTICE GUIDELINES

1. For optimum performance all spectrophotometers should be sited in a clean, dry, dust free atmosphere. When in use ambient temperature and light levels should remain as constant as possible.
2. If required adherence to Standard Operating Procedures (SOP) and Good Laboratory Practice (GLP) should be monitored with regular calibration checks and a suitable Quality Control (QC) programme.
3. The sample chamber lid must be fully closed during measurement and before any readings are recorded or printed.
4. The correct selection of sample containers is imperative for accurate and reproducible results:
  - a) Check that the material of the sample container is compatible with the wavelengths to be used for measurement. In general glass can only be used down to 360nm or 320nm depending on quality. Standard plastic cuvettes can be used down to 320nm. Special UV versions can be used down to 230nm. Below this level quartz cuvettes must be used.
  - b) Plastic disposable cuvettes should only be used ONCE.
  - c) Glass cuvettes should be thoroughly cleaned after use. Discard when scratches become evident on optical surfaces.
  - d) Care should be taken when selecting semi-micro or micro cuvettes. The cuvette window on the inner chamber (the area filled with sample) must be wider than the aperture in the sample holder or light will reach the detector without passing through the sample. In this case, semi-micro or micro cuvettes with self-screening black surrounds must be used or, alternative holders for these cuvettes should be used.
  - e) Glass test tubes and other sample tubes should be used with care. Where possible, matched tubes should be used and any index mark set to the correct position before measurements are made.
  - f) Ensure any sample containers used are compatible with the constituents of both the samples and standards they are to hold. Plastic cuvettes are not compatible with organic solvents.
  - g) All sample containers must be handled with care; by the top, bottom and non-optical surfaces only. Any finger marks evident must be removed by a suitable cleaning process.
  - h) Flow-through cuvettes must be selected with care and consideration for the sample type, sample volume, pumping system, rinse, sample and waste handling to be used.

5. Samples and standards should not be stored in open cuvettes or sample containers as evaporation will change the value and lead to staining of the walls which may be irreversible. If stored in stoppered and sealed cuvettes, they should be filled with little or no air space and the values regularly checked against a reference standard or quality control material.
6. Samples should be allowed to equilibrate to ambient temperature before measurement (unless a suitable temperature controlled sample holder is in use). Temperature change during measurement may cause air bubbles to form on the walls of the sample holder. This is a common cause of drift during measurement.
7. In the preparation of samples and standards high grade borosilicate glass and AR grade chemicals and reagents must be used. Good quality deionised water or other suitable solvents must be used for dissolving or diluting samples, chemicals and reagents.
8. All measurements require calibration to a blank, for maximum accuracy this should be prepared with care using the same deionised water or solvent used for dissolving or diluting the sample. Where reagents are added to the sample to produce a colour proportional to its concentration a 'sample based' blank should be used. In this case the blank should consist of all reagents or chemicals to be used, **except** the sample which will produce the colour to be measured.
9. Deviations from the Beer-Lambert Law may occur at high and low concentrations giving non-linear response during sample concentration measurements. For all new methods a linear range should be defined by the preparation of a calibration curve. The quantitation mode may be used to construct such a curve against which sample results are automatically measured.
10. Cuvettes and sample holders must be filled to a minimum level which covers the light path. All Jenway spectrophotometers have a beam height of 15mm.
11. The instrument must be calibrated to zero absorbance/100% transmittance prior to taking readings. In the spectrum measurement mode a baseline scan must be performed before performing a sample scan.

## SECTION 4 – Instrument Setup

### 4.1 NAVIGATING AND SCREEN SETUP

The main menu screen is displayed below.

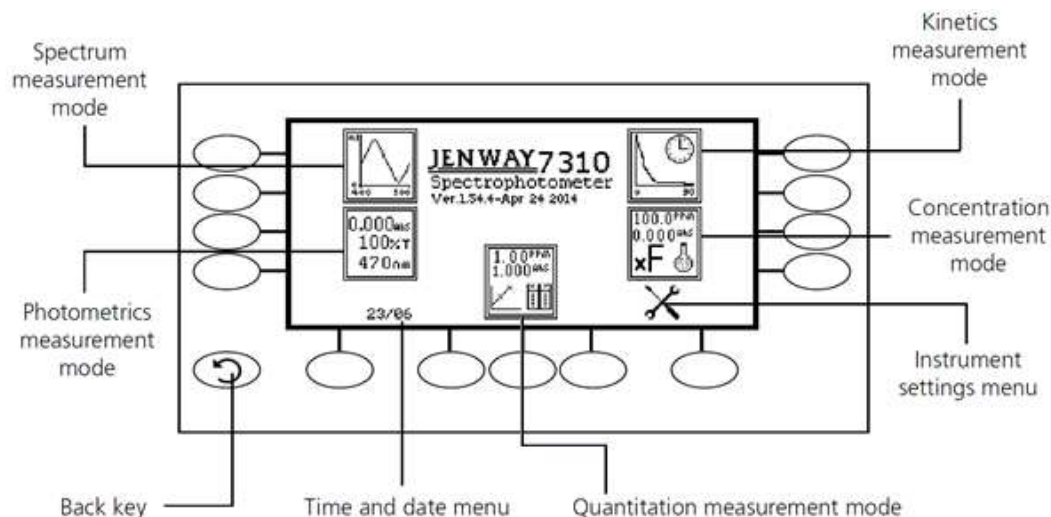

**Fig 4.1 – Home Screen**

To navigate around the spectrophotometer screen press the soft keys adjacent to icons displayed on the screen. In the main menu either of the two soft keys adjacent to the measurement mode icon can be pressed to access the mode. There is a **back** key which returns to the previous menu without saving any changes.

The main menu screen provides access to all five measurement modes, the time and date menu and the instrument settings menu. The measurement modes are spectrum, photometrics, quantitation, concentration and kinetics. The instrument settings menu enables access to settings lock, security codes, method lock, mode selection, user ID, screen contrast and lamp save menus.

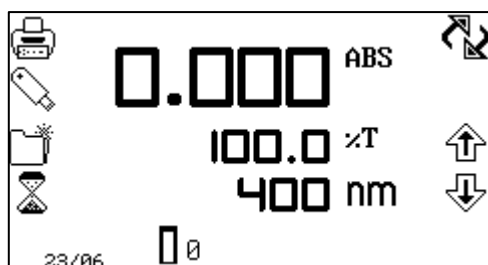

**Operating Menu**

(Photometrics measurement mode)

When a measurement mode is selected the operating menu is opened. This menu enables changes to be made to the measurement parameters and method settings. Depending on the mode, the measurement parameters can be accessed through the settings menu which is displayed in the top right hand corner of the screen. The only mode where this function is not available is the photometrics mode; instead a toggle icon is displayed which is used to change the primary and secondary displays.

The measurement settings can be accessed through the utility toolbar displayed on the left hand

side of the operating menu. This toolbar provides the same functions in all of the measurement modes. The utility toolbar enables access to printing, print setup options, opening, saving and deleting results and methods and autologging options. For more details on the different functions of the utility toolbar refer to section 10.

#### 4.2 TIME AND DATE



The time and date menu enables the current time and date to be set. This information will be saved on all results and displayed on printouts. The time and date menu can be accessed from the main menu by holding the key below the time and date icon for 2 seconds. Pressing the key for less than 2 seconds cycles the display between time and date.

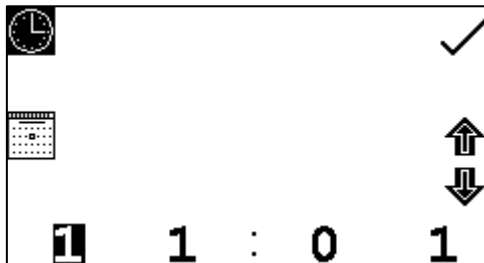

In the time and date menu to set the time press the key adjacent to the clock icon. Select the digit to be changed using the keys at the bottom of the screen. Use the keys adjacent to the arrow icons to increase or decrease the number. The clock function uses a 24 hour format.

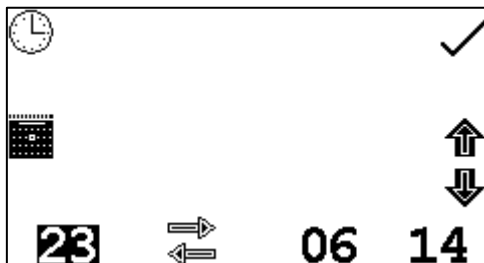

In the time and date menu to set the date press the key adjacent to the calendar icon. Select the digit to be changed using the keys at the bottom of the screen. Use the keys adjacent to the arrow icons to increase or decrease the number. The date format can be displayed as either European dd/mm/yy or American

mm/dd/yy. To change between the two formats press the key below the toggle icon. Once the current time and date have been set press the key adjacent to the tick icon to save the changes. To exit this menu without saving any changes press the back key and the screen will return to the main menu.

فروشگاه تخصصی آزمایشگاهی روناکو

### 4.3 INSTRUMENT SETTINGS MENU

The instrument settings menu is accessed by pressing the key below the instrument settings icon in the main menu. This menu enables access to settings lock, security code, method lock, mode selection, user ID, screen contrast and lamp save menus. The tick icon saves any changes made and returns to the main menu.

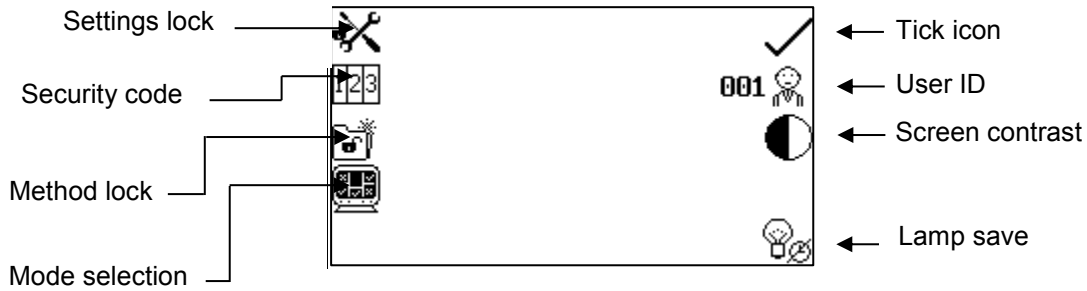
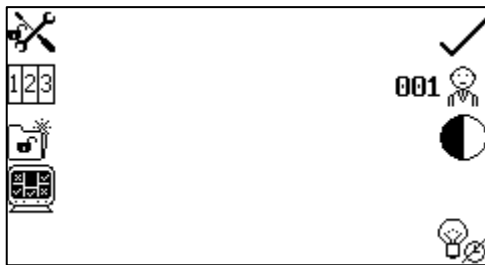

Fig 4.3 - Settings Menu

### 4.4 SECURITY AND SETTING PASSWORDS

#### 4.4.1 Setting Security Codes



The security code function enables a security code to be set to lock the instrument settings and measurement mode settings. The security code is not specific to the user ID but is designed to enable an administrator to control either the instrument or protocols. The security code menu is accessed through the instrument settings menu.

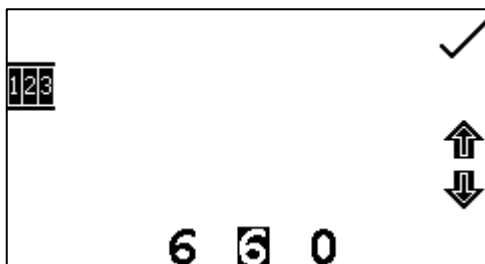

In the instrument settings menu press the key adjacent to the security code icon. Using the keys at the bottom of the screen select the digit to be changed. Use the keys adjacent to the arrow icons to increase or decrease the selected number. Once the preferred code has been set press the key adjacent to the tick icon to save the security code.

فروشگاه تخصصی پزشکی رونماکو

#### 4.4.2 Settings lock

The settings lock function enables the instrument and measurement mode settings to be locked to prevent any changes to the measurement parameters or instrument settings. The only exceptions to this are that the user ID and contrast can be changed when the settings lock is active.



The settings lock function is accessed through the instrument settings menu by pressing the key adjacent to the open padlock icon. One press will lock the settings instantly. To unlock the settings press the key again. This will open the security code menu as detailed in section 4.4.1. The previously set

security code must be entered to unlock the settings. When the settings lock is active methods can still be opened, deleted and saved but the method parameters cannot be changed.

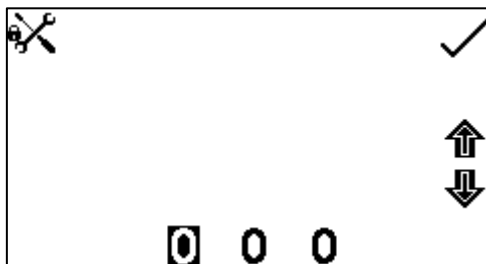

To enter the security code, use the keys at the bottom of the screen to select the digit to be changed. Use the keys adjacent to the arrow icons to increase or decrease the selected number. Once the correct security code has been entered press the key adjacent to the tick icon. The settings are now unlocked.

If the settings are locked before the security code has been set a default code of 660 will unlock the settings.

#### 4.4.3 Method Lock



When the method lock is active the method selection menu is disabled in all the measurement modes therefore methods cannot be opened, deleted or saved. However the measurement parameters of the currently loaded method can be changed. The method lock function is accessed through the

instrument settings menu by pressing the key adjacent to the method lock icon. One press will lock the methods instantly. To unlock the methods press the key adjacent to the method lock icon again. The methods are now unlocked. If the settings lock is active this must be disabled before the method lock can be activated or deactivated.

In all the measurement modes if a user tries to save changes to a method when the method lock



is active the padlock icon flashes on the screen and changes cannot be saved.

#### 4.5 MODE SELECTION

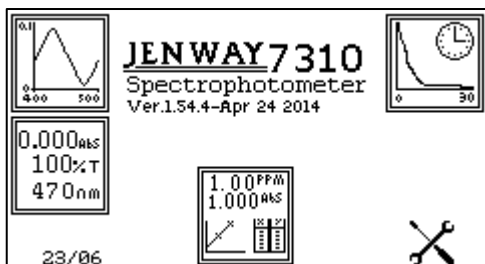
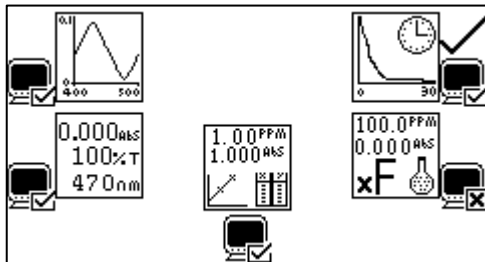
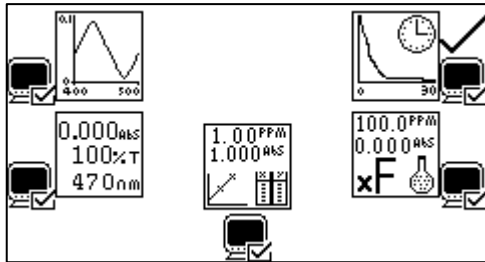

The mode selection function enables access to the various measurement modes to be restricted. The required modes can be selected and the settings lock activated to prevent other users from accessing the deactivated modes. The mode selection function can be accessed through the instrument settings menu by pressing the key adjacent to the mode selection icon. The measurement mode icons which are displayed on the main menu are identified with a mode shown icon. The mode icons which are not displayed on the main menu are identified with a mode not shown icon. To change a mode from displayed to restricted or vice versa press the key adjacent to the measurement mode icon. Once the required modes have been selected press the key adjacent to the tick icon to save the changes. The selected measurement modes will be displayed on the main menu.

#### 4.6 GLP SETTINGS

In addition to the time and date settings these instruments also have a user ID function. This function enables an individual three digit ID number to be set. This will be displayed on all printouts and saved results.

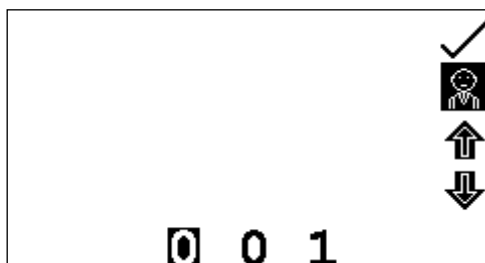

The user ID function can be accessed through the instrument settings menu by pressing the key adjacent to the user ID icon. Use the keys at the bottom of the screen to select the digit to be changed. Use the keys adjacent to the arrow icons to increase or decrease the number. Once the preferred

user ID has been set press the key adjacent to the tick icon to save and return to the instrument settings menu.

#### 4.7 SCREEN CONTRAST

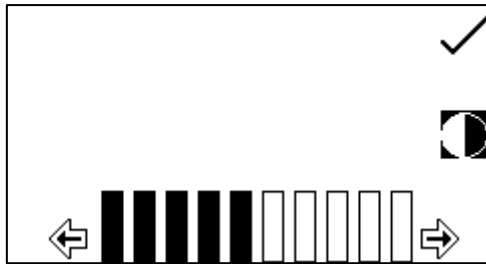

The screen contrast function enables the brightness of the screen to be set. In the instrument settings menu press the key adjacent to the screen contrast icon. Use the keys below the arrow icons to increase or decrease the screen contrast. Once the required contrast level has been reached press the key adjacent to the tick icon to save and return to the instrument settings menu.

#### 4.8 LAMP SAVE

This function is only available on the 7310 visible spectrophotometer which uses a tungsten halogen lamp.



The lamp save function enables the time in minutes to be set after which the lamp will be turned off following a period of no lamp activity, i.e. no readings have been performed. This function is accessed through the instrument settings menu by pressing the key adjacent to the lamp save icon.

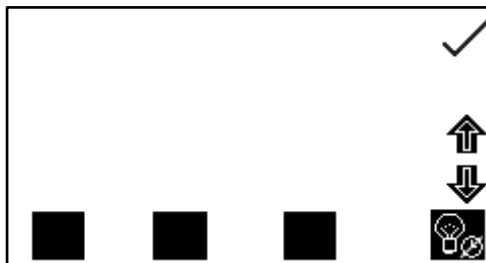

When this menu is first accessed the lamp save is turned off. To activate the lamp save function press the key below the lamp save icon. To deactivate the lamp save function press the key below the lamp save icon.

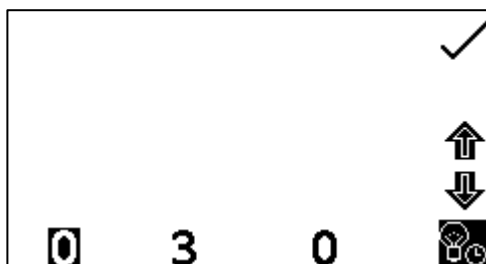

The default minimum time is set to 30 minutes. Select the digit to be changed using the keys at the bottom of the screen. Use the keys adjacent to the arrow icons to increase or decrease the number. Once the required time in minutes has been set press the key adjacent to the tick icon to save and return to the instrument settings menu.

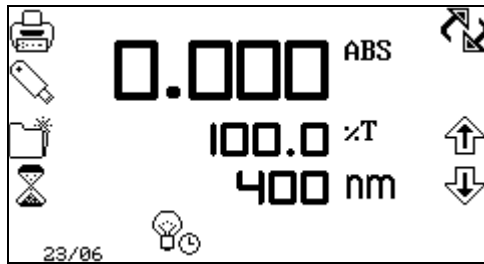

The time set will begin to count down when there is no lamp activity. When the countdown is complete the lamp and the fan will be turned off and the lamp save icon is shown in all the measurement modes. To bring the instrument out of the lamp save in order to perform a measurement press the key below the lamp save icon. The lamp and fan will be turned back on and the lamp will begin to warm up.

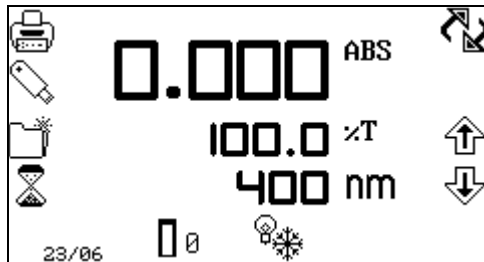

The lamp cold icon is displayed adjacent to the calibrate to zero icon in the measurement mode. The time needed for the lamp to warm up is five minutes.



To view the remaining warm up time press the key below the lamp cold icon. Calibration and measurements can be performed whilst the lamp is warming up but these results may not be accurate.

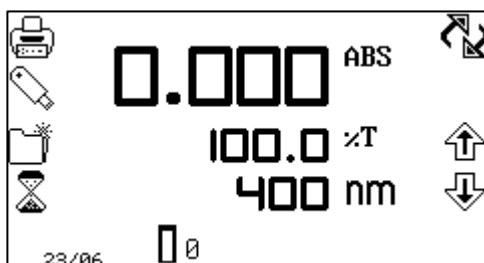

Once the warm up time of five minutes is complete the lamp cold icon disappears.

## SECTION 5 – PHOTOMETRICS

The photometrics measurement mode enables simple measurements of absorbance and % transmittance to be performed. The sample is measured at one wavelength and at one point in time. There are no post measurement calculations available in this measurement mode.

### 5.1 MODE SPECIFIC PARAMETERS

The photometrics operating menu enables measurement parameters to be changed. The utility toolbar on the left hand side of the screen enables access to printing, print setup options, results, methods and autologging options. For more details on the different functions of the utility toolbar refer to section 10.

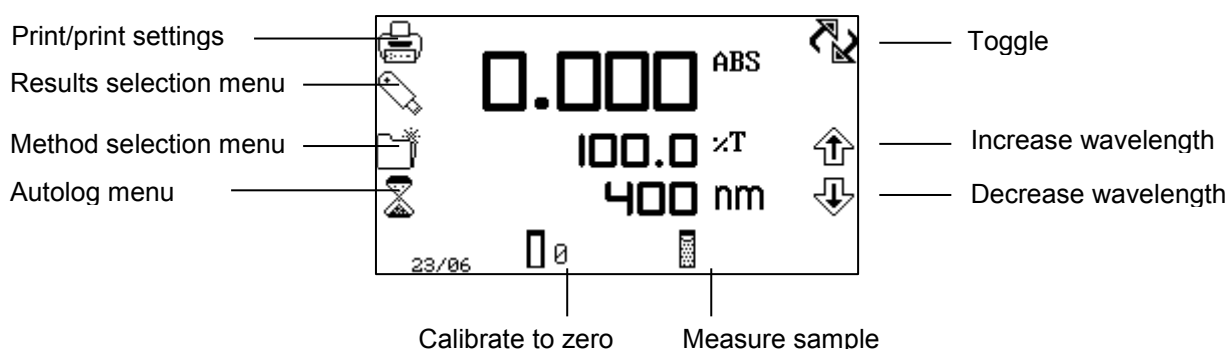
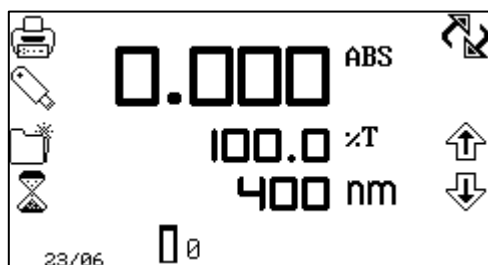

Fig 5.1 - Operating Menu

### 5.2 METHOD SET UP



This measurement mode is very simple and the only parameters which can be adjusted are the wavelength and the display format.

The toggle icon enables the large primary display to be set to show the absorbance or % transmittance. To change the primary and secondary displays press the key adjacent to the toggle icon. Repeat presses will cycle the displays between absorbance or % transmittance.

#### 5.2.1 Selecting a Wavelength

The wavelength can be adjusted in the operating menu by using the keys adjacent to the arrow icons to increase or decrease the wavelength. Once the required wavelength has been selected a calibration can be performed.

### 5.3 CALIBRATION

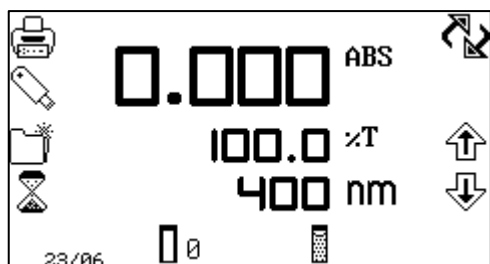

The calibration must be performed at the same wavelength at which the sample will be measured. Insert a cuvette containing the blank solution into the sample chamber and close the instrument lid. Press the key below the calibrate to zero absorbance icon. This sets the instrument to zero absorbance and 100% transmittance.

Once the calibration is complete the measure sample icon appears and the sample can be measured. If the wavelength is adjusted before a sample is measured the measure sample icon will disappear and the instrument must be calibrated again at the new wavelength.

### 5.4 SAMPLE MEASUREMENT

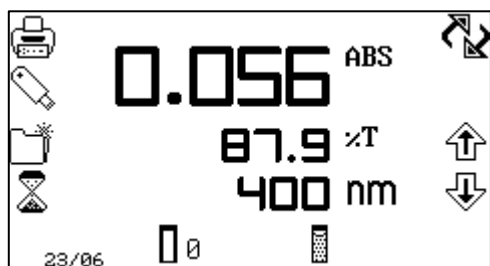

It is not possible to measure a sample before the instrument has been calibrated at the selected wavelength. Once the calibration has been performed the measure sample icon is displayed and a sample can be measured. Remove the cuvette containing the blank solution and place a cuvette containing the

sample to be measured in the sample holder. Close the instrument lid and press the key below the measure sample icon. Once the measurement is complete the photometric result will be shown on the screen.

Subsequent samples can be measured in the same way. If the wavelength is adjusted between sample measurements then the instrument must be calibrated again before more samples can be measured.

فروشگاه تجهیزات آزمایشگاهی روناکو

## SECTION 6 – CONCENTRATION

The concentration measurement mode enables simple measurements of absorbance and concentration to be performed. In this measurement mode it is possible to calibrate against a standard of a known concentration or use a known factor. The sample is measured at one wavelength at one point in time. There are no post measurement calculations available in this measurement mode.

### 6.1 MODE SPECIFIC PARAMETERS

The concentration operating menu enables measurement parameters to be changed. The utility toolbar on the left hand side of the screen enables access to printing, print setup options, results, methods and autologging options. For more details on the different functions of the utility toolbar refer to section 10. The settings icon enables the wavelength, units, resolution, standard or factor to be set.

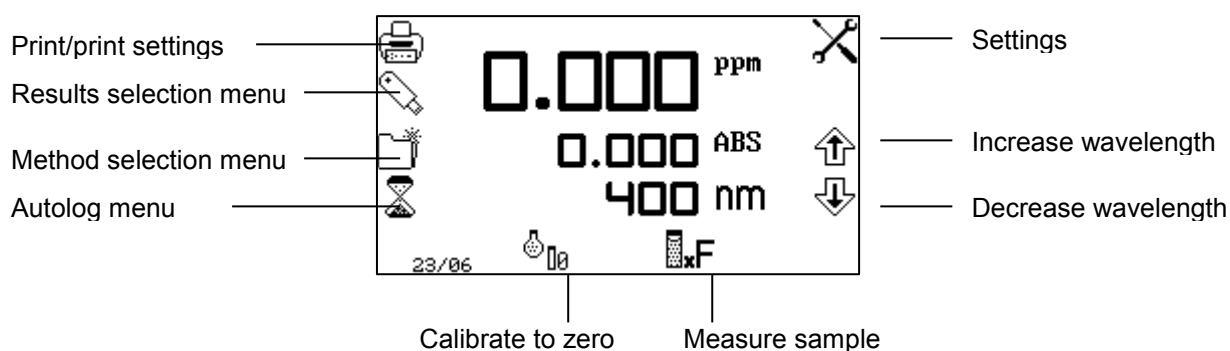
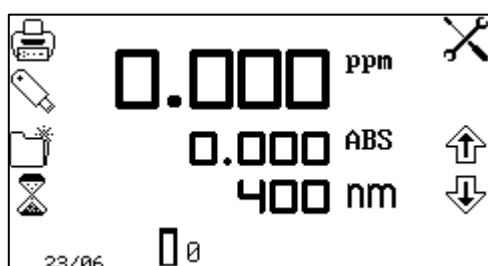

Fig 6.1 - Operating Menu

### 6.2 METHOD SETUP

#### 6.2.1 Selecting a Wavelength



The wavelength can be adjusted in the operating menu or in the settings menu. To adjust the wavelength, in the operating menu, use the keys adjacent to the arrow icons to increase or decrease the wavelength.

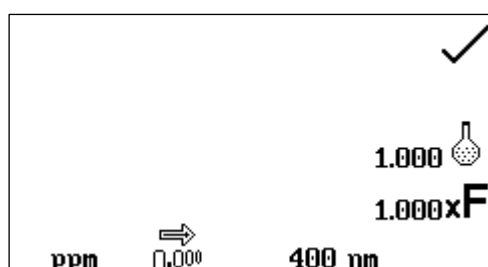

The settings menu is accessed through the operating menu by pressing the key adjacent to the settings icon. In the settings menu press the key below the wavelength icon.

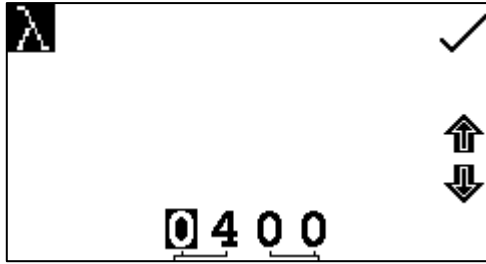

This will open a number entry screen. Use the keys at the bottom of the screen to select the digit to be adjusted. Use the keys adjacent to the arrow icons to increase or decrease the wavelength to the required number. Press the key adjacent to the tick icon to save the changes and return to the settings menu.

## 6.2.2 Settings

The settings menu enables the wavelength, units, resolution, standard or factor to be set and is accessed from the operating menu by pressing the key adjacent to the settings icon. Once all of the required settings have been entered press the key adjacent to the tick icon to save and return to the operating menu.

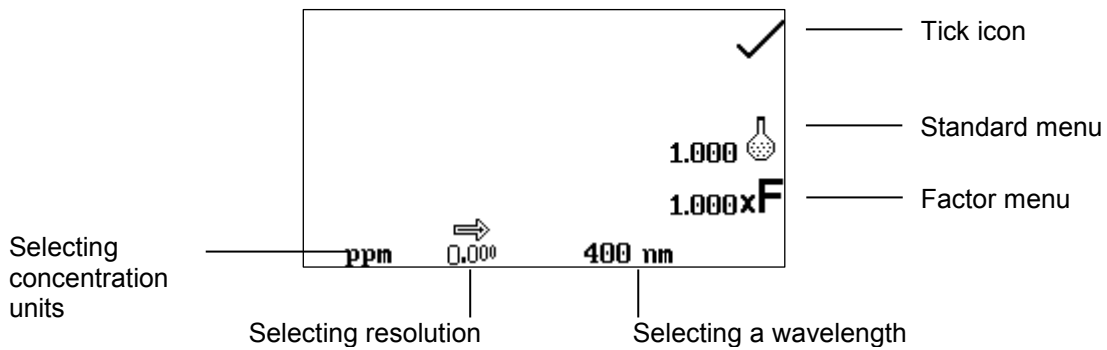
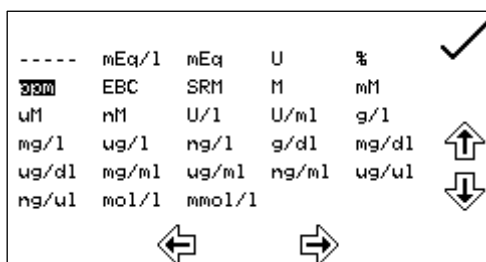

**Fig 6.2.2 – Settings Menu**

When setting the method parameters either the standard or the factor should be selected. The standard should be used if the factor is not known as selecting this option will calculate the factor. If the factor is known it is not necessary to measure a known standard's concentration. When the standard or factor is not selected the value should be set to 1.00.

### 6.2.2.1 Selecting Concentration Units

The units of concentration can be selected from a number of options: no units, %, ppm, EBC, SRM, mEq/l, mEq, M, mM, μM, nM, U, U/l, U/ml, g/l, mg/l, μg/l, ng/l, g/dl, mg/dl, μg/dl, mg/ml, μg/ml, ng/ml, μg/μl, ng/μl, mol/l, mmol/l.



In the settings menu press the key below the units icon. This opens the unit selection screen which displays all the different units. Use the keys adjacent to the arrow icons to navigate around the screen to select the required units. Once the required units have been highlighted press the key adjacent to the tick icon to

save and return to the settings menu. The selected unit will be displayed in the operating menu along with the absorbance value and the selected wavelength.

### 6.2.2.2 Changing the Resolution

The resolution that the concentration is displayed as can be selected from 1, 0.1, 0.01 or 0.001 by repeat presses of the key below the resolution icon in the settings menu.

### 6.2.2.3 Using a Standard

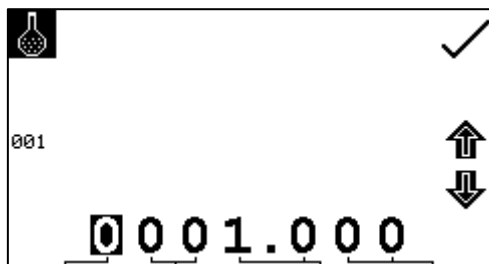

The standard menu enables the value of a standard to be entered. This function is accessed by pressing the key adjacent to the standard icon. This opens the extended number entry screen. Use the keys at the bottom of the screen to select the digit to be changed. The key below the digit must be pressed twice to select

the adjacent digit. For example 00 the first press of the key alters 10, the second press alters 01. Use the keys adjacent to the arrow icons to increase or decrease the selected number. Standard values from 0.001 to 1000 can be entered. The standard value can be reset to one by pressing the key adjacent to the 001 icon. Once the standard value has been entered press the key adjacent to the tick icon to save and return to the settings menu. The entered value is displayed in the settings menu adjacent to the standard icon.

A standard value should only be entered if the factor is not known. If the factor is known the standard value should be set to 1.000.

### 6.2.2.4 Using a Factor

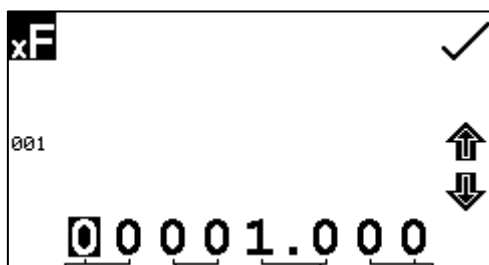

The factor menu enables a factor to be entered. This function is accessed by pressing the key adjacent to the factor icon. This opens the extended number entry screen. Use the keys at the bottom of the screen to select the digit to be changed. The key below the digit must be pressed twice to select the adjacent digit.

For example 00 the first press of the key alters 10, the second press alters 01. Use the keys adjacent to the arrow icons to increase or decrease the selected number. Factor values of 0.001 to 10,000 can be entered. The factor value can be reset to one by pressing the key adjacent to the 001 icon. Once the factor has been entered press the key adjacent to the tick icon to save and return to the settings menu. The entered value is displayed in the settings menu adjacent to the factor icon.



If the factor is not known a standard should be measured in order to calculate the factor. If a standard is used the factor value should be set to 1.000.

### 6.3 CALIBRATION

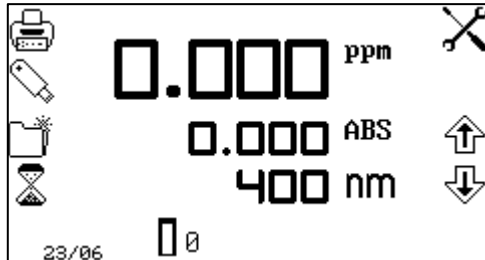

In the concentration measurement mode calibrations against a standard or a factor can be performed following a zero calibration. If the factor is not known calibration against a known standard is performed in order to calculate the factor. However if the factor is known there is no need to calibrate using a standard.

The calibration must be performed at the same wavelength at which the sample will be measured.

#### 6.3.1 Calibrating to a Standard

Insert a cuvette containing the blank solution into the sample chamber and close the instrument lid. Press the key below the calibrate to zero absorbance icon. The instrument will calibrate to zero absorbance. Insert a cuvette containing the standard concentration sample solution into the sample chamber and close the instrument lid.

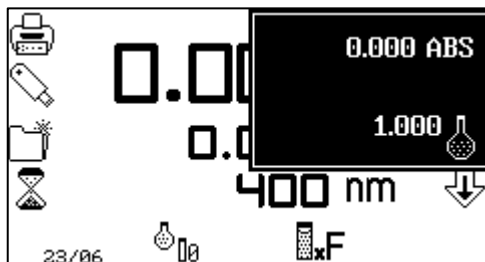

Press the key below the calibrate to zero absorbance or standard icon, this will open another menu with the option to re-calibrate to zero absorbance or to calibrate to the previously entered standard value. Press the key adjacent to the calibrate to standard icon.

If the standard selected requires a factor beyond the range of the instrument the check standard icon will be displayed.

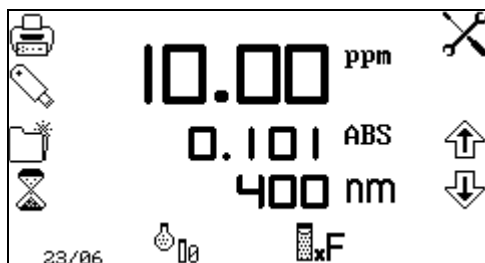

The instrument will take a reading and calibrate to the standard concentration. Once the calibration is complete the sample can be measured using the measure to standard icon.

فروشگاه تجهیزات آزمایشگاهی روناسی

### 6.3.2 Calibrating to a Factor

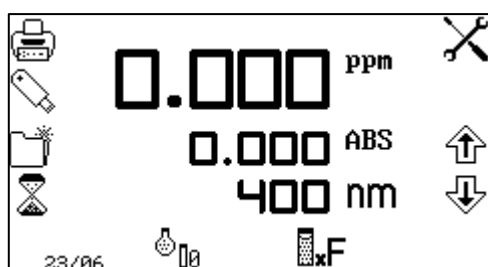

Insert a cuvette containing the blank solution into the sample chamber and close the instrument lid. Press the key below the calibrate to zero absorbance icon. The instrument will calibrate to zero absorbance. Once the calibration is complete the sample can be measured using the measure to factor icon.

## 6.4 SAMPLE MEASUREMENT

It is not possible to perform sample measurements before the instrument has been calibrated at the selected wavelength. In this operating mode the type of sample measurement performed depends on the calibration which has been carried out.

### 6.4.1 Measuring a Sample After Calibrating to a Standard

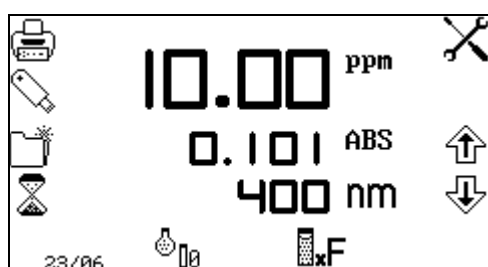

Remove the cuvette containing the standard sample and place a cuvette containing the sample to be measured in the sample chamber. Close the instrument lid and press the key below the measure to standard icon. Once the measurement is complete the concentration and absorbance values are displayed.

### 6.4.2 Measuring a Sample After Calibrating to a Factor

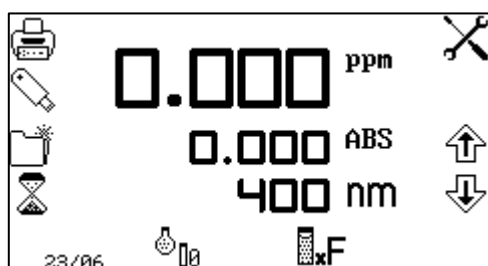

Remove the cuvette containing the blank solution and place a cuvette containing the sample to be measured in the sample chamber. Close the instrument lid and press the key below the measure to factor icon. Once the measurement is complete the concentration and absorbance values are displayed.

In order to measure a sample based on a known factor the value for the factor must be entered in the settings menu before commencing measurement of the sample.

## 6.5 POST MEASUREMENT OPTIONS

Post measurement changes to the selected concentration units, the concentration factor and the calibration standard values are restricted.

### 6.5.1 Changing Concentration Units

Users can adjust the displayed concentration unit after a measurement. If the measurements concentration unit is updated, the instrument will adjust the displayed concentration value to reflect the new selection. This functionality is limited to ensure that the user can only update the measurement unit to one that is a direct conversion from the original measurement unit. These restrictions are summarized in Table 6.5.1, where the selectable measurement units are grouped according to those which are interchangeable after a measurement.

Interchangeable Measurement Units								
1	2	3	4	5	6	7	8	9
%	EBC	mEq/l	mEq	M	U	U/l	g/l	mol/l
ppm	SRM			mM		U/ml	mg/l	mmol/l
				uM			ug/l	
				nM			ng/l	
							g/dl	
							mg/dl	
							ug/dl	
							mg/ml	
							ug/ml	
							ng/ml	
							ug/ul	
							ng/ul	

Table 6.5.1 – Post Measurement Unit Change Restrictions



Once a measurement is complete, press the key adjacent to the settings icon, then press the key below the units icon. This will either cycle through the available unit options or open the units selection page.

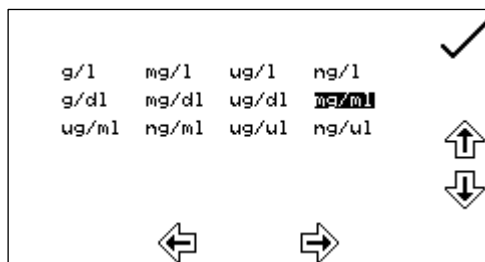

In the units selection page, select the updated measurement unit from the available options and press the key adjacent to the tick icon to confirm.

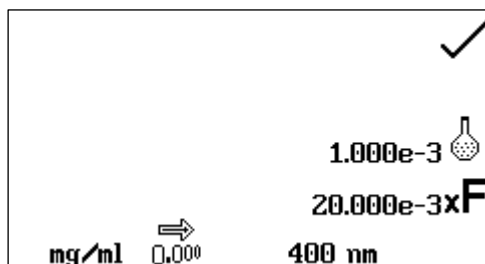

In the concentration settings menu, the calibration standard and concentration factor values are updated.

فروشگاه تجهیزات آزمایشگاهی روناکو

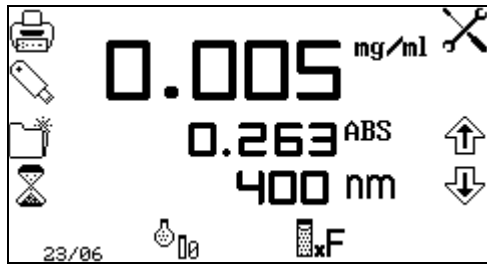

The updated concentration value and unit are shown in the main display.

### 6.5.2 Changing the Concentration Factor

Users cannot adjust the concentration factor once a blank measurement is performed. If the concentration factor needs to be changed, the user must exit and re-enter the concentration measurement mode.

### 6.5.3 Changing the Calibration Standard Value

Users cannot adjust the calibration standard value once a blank measurement is performed. If the calibration standard value needs to be changed, the user must exit and re-enter the concentration measurement mode.

فروشگاه تجهیزات آزمایشگاهی روناکو

## SECTION 7 – SPECTRUM

The spectrum measurement mode enables measurements of absorbance or % transmittance over a range of wavelengths to be performed. The absorbance or % transmittance at each wavelength is plotted graphically. Post measurement tools such as peaks and valleys analysis and spectral points analysis can be performed. This operating mode can be used to partially characterise a sample.

### 7.1 MODE SPECIFIC PARAMETERS

The spectrum operating menu enables measurement parameters to be changed. The utility toolbar on the left hand side of the screen enables access to printing, print setup options, results, methods and autologging options. For more details on the different functions of the utility toolbar refer to section 10.

The scan settings icon enables the graph y-axis, absorbance or % transmittance operating mode, start and end wavelengths and scan interval to be set. The peaks and valleys threshold icon enables the peaks and valleys threshold to be set. The peaks and valleys table icon enables the peaks and valleys of the scan to be viewed in tabular form. The spectral points analysis icon enables points to be selected from the scan for post measurement analysis.

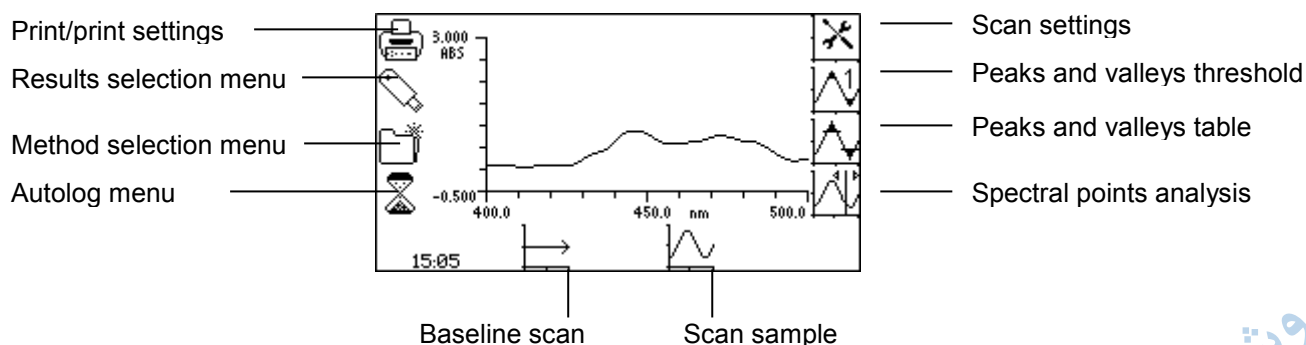
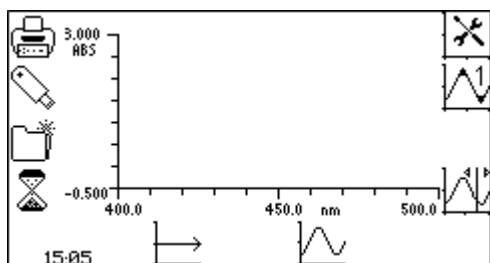

Fig 7.1 - Operating Menu – Post Measurement

### 7.2 METHOD SETUP



In this measurement mode all of the method setup parameters are accessed through the scan settings menu. To open the scan settings menu press the key adjacent to the scan settings icon in the operating menu.

### 7.2.1 Scan Settings

This function enables the graph y-axis, absorbance or % transmittance operating mode, start and end wavelengths and scan interval to be set. To access this function press the key adjacent to the scan settings icon in the operating menu.

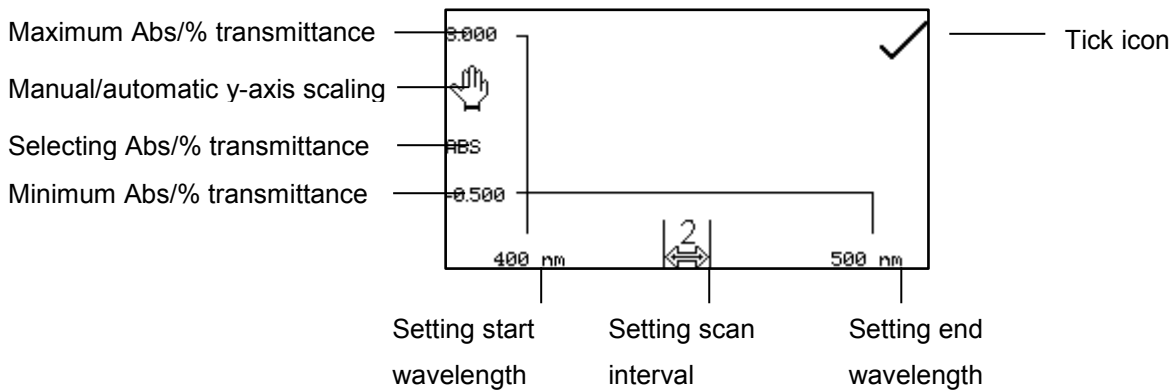

**Fig 7.2.1 – Scan Settings Menu**

### 7.2.2 Selecting Absorbance or % Transmittance

The operating mode is displayed on the left hand side of the menu. The default parameter is absorbance and pressing the key adjacent to the ABS icon cycles the operating mode between absorbance and % transmittance.

### 7.2.3 Setting Start and End Wavelengths

This function enables the start and end wavelengths of the spectrum scan to be set. Model 7310 has a spectrum range from 320nm to 1000nm; model 7315 has a spectrum range from 198 to 1000nm. To set the start wavelength in the scan settings menu press the key adjacent to the wavelength on the far left of the x-axis. This opens the number entry screen. Use the keys at the bottom of the

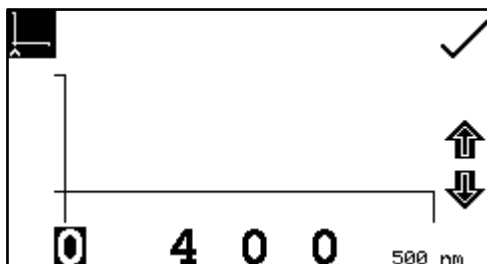

screen to select the digit to be changed and use the keys adjacent to the arrow icons to increase or decrease the number. Once the required start wavelength has been entered press the key adjacent to the tick icon to save and return to the scan settings menu.

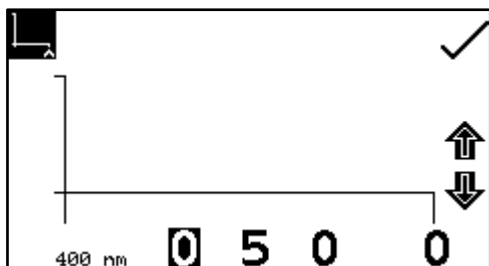

To set the end wavelength in the scan settings menu press the key adjacent to the wavelength icon on the far right of the x-axis. This opens the number entry screen. Use the keys at the bottom of the screen to select the digit to be changed and use the arrow keys to increase or decrease the number. Once the

required end wavelength has been entered press the key adjacent to the tick icon to save and return to the scan settings menu.

If the start wavelength entered is the same as the end wavelength the end wavelength will automatically be set to be one times the scan interval. For example, if the start wavelength is entered as 500nm but the end wavelength is already set to 500nm and the scan interval is 2nm, the end wavelength will be automatically adjusted to 502nm. If the end wavelength entered is the same as the start wavelength the start wavelength will automatically be set to be one times the scan interval. For example, if the end wavelength is entered as 500nm but the start wavelength is already set to 500nm and the scan interval is 2nm, the start wavelength will be automatically adjusted to 498nm.

#### 7.2.4 Setting the Scan Interval

This function enables the interval between wavelengths measured in the spectrum scan to be set. The scan interval can be altered to 1, 2 or 5nm by pressing the key below the scan interval icon. Repeat pressing of the key cycles the interval between 1, 2 or 5nm. The scan interval can only be selected if the wavelength range is divisible by this number. For example a scan interval of 5nm cannot be selected for a wavelength range of 400 to 503nm.

#### 7.2.5 Y-Axis Scaling

This function enables the scale of the y-axis of the spectrum graph to be adjusted either manually or automatically. The automatic scaling is represented by the hand icon with a cross through it and the manual scaling by the hand icon without the cross. To select manual or automatic scaling press the key adjacent to the hand icon. Repeat pressing of the key cycles between manual and automatic scaling.

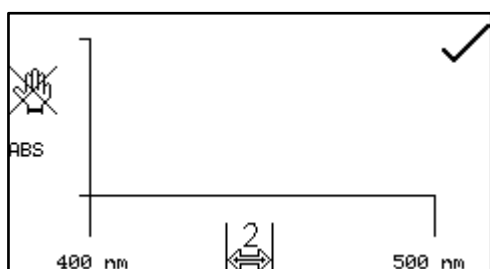

**Automatic Scaling**

In automatic y-axis scaling the absorbance or % transmittance values are cleared from the settings screen. When the spectrum scan has been completed the y-axis is automatically re-scaled.

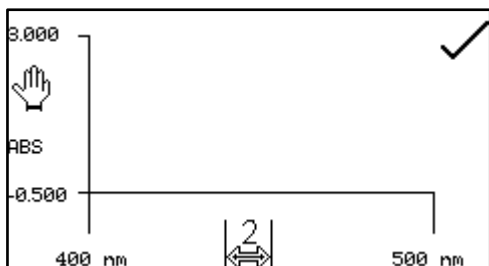

**Manual Scaling**

In manual scaling the minimum and maximum absorbance or % transmittance values can be set. To change the absorbance or % transmittance values press the key adjacent to the minimum y-axis value, this opens a number entry screen.

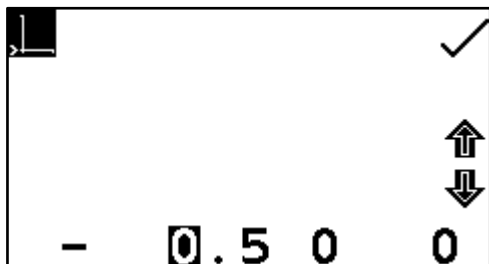

Use the keys at the bottom of the screen to select the digit to be changed and use the keys adjacent to the arrow icons to increase or decrease the number. To change the sign press the key below the + or - icon. Repeat presses will cycle between + and -. Once the required absorbance or % transmittance value has been entered press the key adjacent to the tick icon.

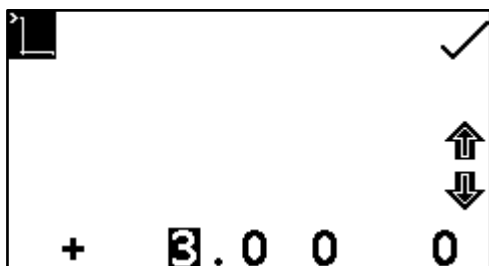

To change the maximum absorbance or % transmittance value press the key adjacent to the maximum y-axis value, this opens a number entry screen. Use the keys adjacent to the arrow icons to increase or decrease the number. To change the sign press the key below the + or - icon. Repeat presses will

cycle between + and -. Once the required absorbance or % transmittance value has been entered press the key adjacent to the tick icon.

### 7.3 CALIBRATION

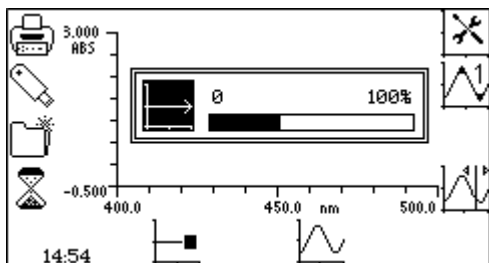

In the spectrum measurement mode the calibration is a baseline scan which is performed across the selected wavelength range at the selected scan interval. Insert a cuvette containing the blank solution into the sample chamber and close the instrument lid. Press the key below the baseline scan icon to initiate the baseline

scan. The baseline icon will change to show baseline scan in progress icon and a progress bar will be displayed.



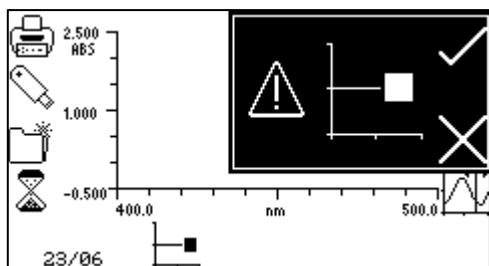

To stop the baseline scan before completion press the key below the baseline scan in progress icon. Confirmation will be needed to stop the baseline scan. Press the key adjacent to the tick icon to confirm stopping the baseline scan and return to the operating menu.

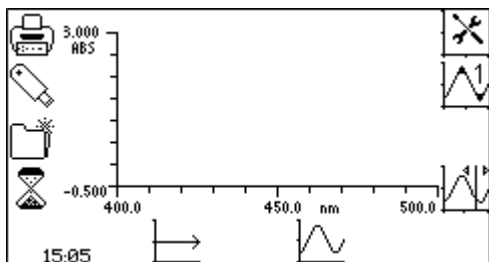

Press the key adjacent to the cross icon to continue the baseline scan. Once the baseline scan has been completed the scan sample icon is displayed and a sample can be measured.

If the wavelength range, or the scan interval, is changed before a sample scan is performed a new

baseline scan must be performed across the new wavelength range, at the new scan interval, before a sample can be measured.

#### 7.4 SAMPLE MEASUREMENT

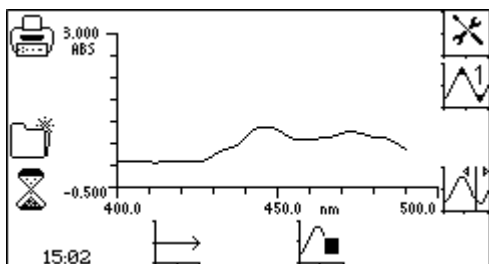

It is not possible to measure a sample before a baseline scan has been performed. Insert a cuvette containing the sample to be measured in the sample chamber and close the instrument lid. Press the key below the scan sample icon to start the spectrum scan of the sample.

The instrument will perform a scan across the wavelength range and scan interval previously selected. The scan sample icon will change to show the spectrum scan is in progress icon.

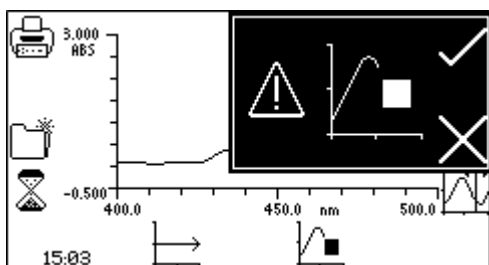

To stop the scan before completion press the key below the scan in progress icon. Confirmation will be needed to stop the sample scan. Press the key adjacent to the cross icon to continue with the scan of the sample or press the key adjacent to the tick icon to confirm stopping the scan.

Depending on how many data points have been measured either a partial scan and all the post measurement tools will be displayed, or the instrument will return to the operating menu with no measurements saved.

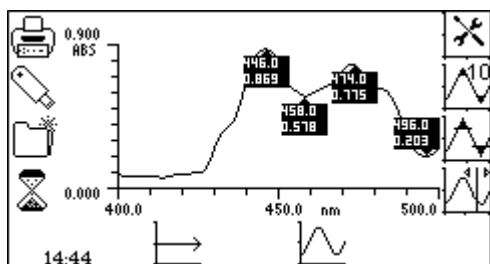

Once the scan is completed the spectrum will be shown on the screen. If automatic scaling was selected the y-axis will automatically be re-scaled.

## 7.5 DATA ANALYSIS

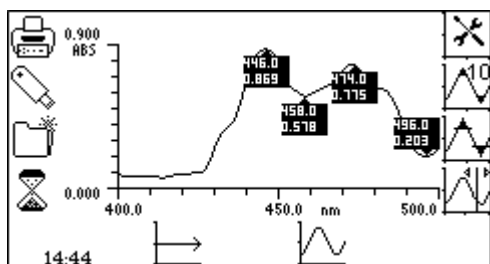

The post measurement tools icons are displayed on the screen following the completion of the scan. The tools include peaks and valleys threshold, peaks and valleys table and spectral points analysis. The peaks and valleys table displays all the detected peaks and valleys above the selected threshold value.

The spectral points analysis function enables points to be selected from the scan to analyse absorbance or % transmittance at selected wavelengths.

### 7.5.1 Peaks and Valleys Threshold

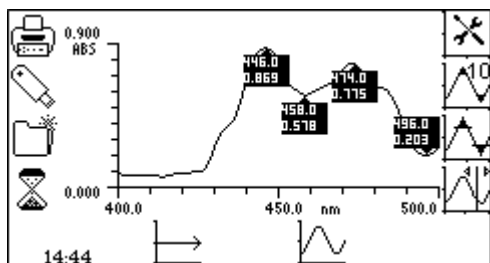

This function enables the peaks and valleys threshold to be set at 1, 5, 10% or turned off. To select the threshold value press the key adjacent to the peaks and valleys threshold icon. Repeat presses of the key will cycle through 1%, 5%, 10% and off.

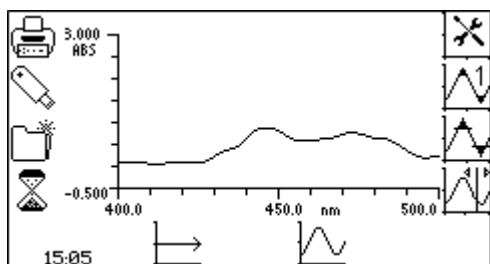

If the peaks and valleys are turned off this is represented by the peaks and valleys icon with a cross in place of a number. When the peaks and valleys threshold is switched off the peaks and valleys table icon is not displayed. If a 5% threshold is selected then only peaks and valleys above this threshold will be

displayed in the peaks and valleys table. The threshold is calculated as:

$$\frac{\left( \frac{\text{Wavelength range}}{\text{Abs or \%T range}} \right)}{\left( \frac{\text{Threshold}}{\text{Percentage}} \right)}$$

## 7.5.2 Peaks and Valleys Table

nm	ABS	
412	----	0.065
446	0.871	----
458	----	0.579
474	0.778	----
496	----	0.202

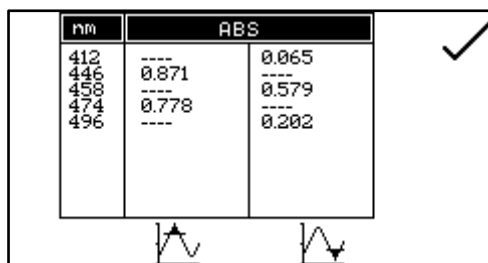

This function displays all the detected peaks and valleys above the selected threshold, in tabular form. To open the table press the key adjacent to the peaks and valleys table icon. If the peaks and valleys threshold is switched off this icon is not displayed.

nm	ABS	
446	0.871	----
474	0.778	----

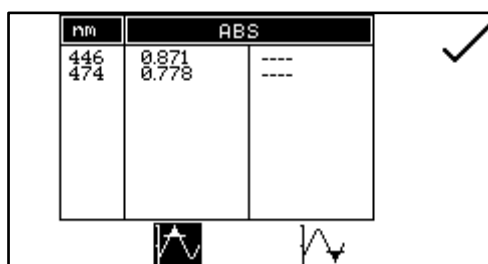

In the peaks and valleys table screen it is possible to display both peaks and valleys, just peaks or just valleys. To display the peaks only press the key below the peak only icon. To redisplay the peaks and valleys press the same key again.

nm	ABS	
412	----	0.065
458	----	0.579
496	----	0.202

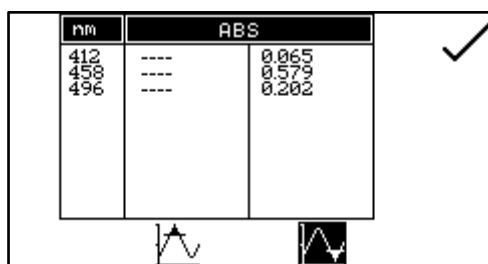

To display the valleys only press the key below the valley only icon. To redisplay the peaks and valley press the same key again.

In the table the absorbance or % transmittance values (depending on the operating mode selected in the scan settings) are shown with the corresponding wavelength. Use the keys adjacent to the arrow icons to scroll up or down through the readings in the table. Press the key adjacent to the tick icon to return to the operating menu.

## 7.5.3 Spectral Points Analysis

The spectral points analysis function enables points to be selected from the scan to analyse the absorbance or % transmittance at a selected wavelength. To access this function press the key adjacent to the spectral points analysis icon and this opens the selection screen.

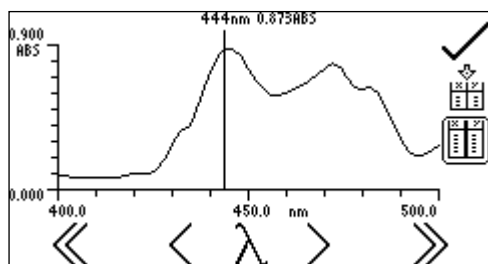

A solid vertical line will appear on the far right of the screen. Use the keys below the greater than (>) or less than (<) icons to move the line along the spectrum by decreasing or increasing the wavelength by one scan interval, the double greater than (>>) or less than (<<) icons increase or decrease the wavelength by ten times the scan interval.

As the vertical line moves along the scan the wavelength and absorbance or % transmittance value is displayed at the top of the screen. To add the selected point from the spectrum to the spectral points analysis table press the key adjacent to the add points to spectral points analysis table icon.

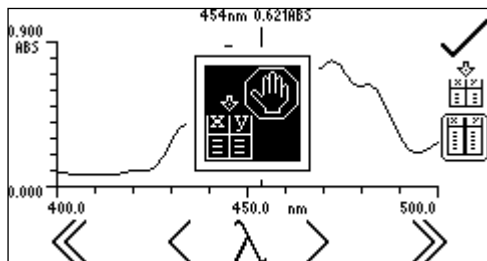

Only 6 points can be stored in the spectral points analysis table. When adding a selected point to the table the position this point is in the table will flash up on the screen. If the table is full and a 7<sup>th</sup> point is selected to go into the table a warning symbol will flash up and a point must be deleted from the table before another point can be added.

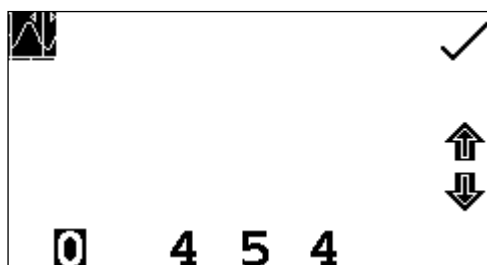

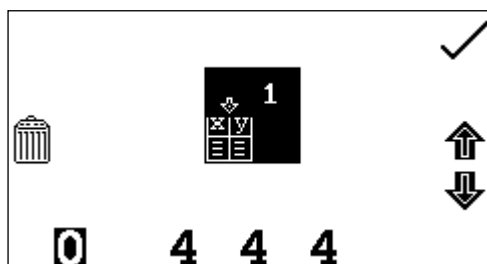

The wavelength to be analysed can also be entered manually. This can be done in two ways; firstly by pressing the key below the wavelength icon in the spectral points analysis menu. This opens a number entry screen where the wavelength can be input manually. Use the keys at the bottom of the screen to

select the digit to be changed and use the keys adjacent to the arrow icons to increase or decrease the number. Once the wavelength has been entered press the key adjacent to the tick icon to save and return to the spectral points analysis menu.





Secondly, the wavelength can also be entered manually in the spectral points analysis table by pressing the key adjacent to the location in the table where the result is to be stored. This opens a number entry screen where the analysis point can also be deleted by pressing the key adjacent to the delete icon.

Use the keys at the bottom of the screen to select the digit to be changed and use the keys adjacent to the arrow icons to increase or decrease the number. Once the required wavelength has been entered or the analysis point deleted press the key adjacent to the tick icon to save and return to the spectral points analysis table. If a wavelength entered is outside the scan range the check number warning icon will be displayed before the wavelength is automatically adjusted to within the range.

$\lambda$ (nm)		ABS
444	1	0.873
446	2	0.873
448	3	0.833
		

%T

$\lambda$ (nm)		ABS
450	4	0.756
452	5	0.678
454	6	0.621
		

%T

To view the points in the spectral points analysis table press the key adjacent to the spectral points analysis table icon. Only three points can be displayed on the screen at one time; to view the other points in the table press the key below the down arrow icon. To view the first three points again press the key below the up arrow icon. The table displays the wavelength and either the corresponding absorbance or % transmittance, as well as the order in which the points were selected or entered. To change the photometric value between absorbance or % transmittance press the key below the ABS icon or %T icon. Pressing the key adjacent to the tick icon will save any changes made and return to the spectral points analysis menu.

It is possible to access spectral points analysis before a scan is performed. Points to be analysed can be pre-selected from the blank axis, or entered manually in the spectral points analysis table. When the scan has been performed the points for analysis will already be in the table with the corresponding absorbance or % transmittance values.

فروشگاه تجهیزات آزمایشگاهی روناکو

## SECTION 8 – QUANTITATION

The quantitation measurement mode enables sample concentrations to be calculated using a standard curve. In this mode a number of standard solutions covering a range of known concentrations are measured at a set wavelength. The absorbance or % transmittance of these solutions is plotted to create a standard curve. Once the standard curve has been created a sample of unknown concentration can be measured and the concentration calculated using the standard curve.

### 8.1 MODE SPECIFIC PARAMETERS

The quantitation operating menu enables measurement parameters to be changed. The utility toolbar on the left hand side of the screen enables access to printing, print setup options, results, methods and autologging options. For more details on the different functions of the utility toolbar refer to section 10.

The standard curve icon enables the current standard curve and curve statistics to be viewed or a new standard curve to be created. The quantitation table icon enables the quantitation standards to be viewed.

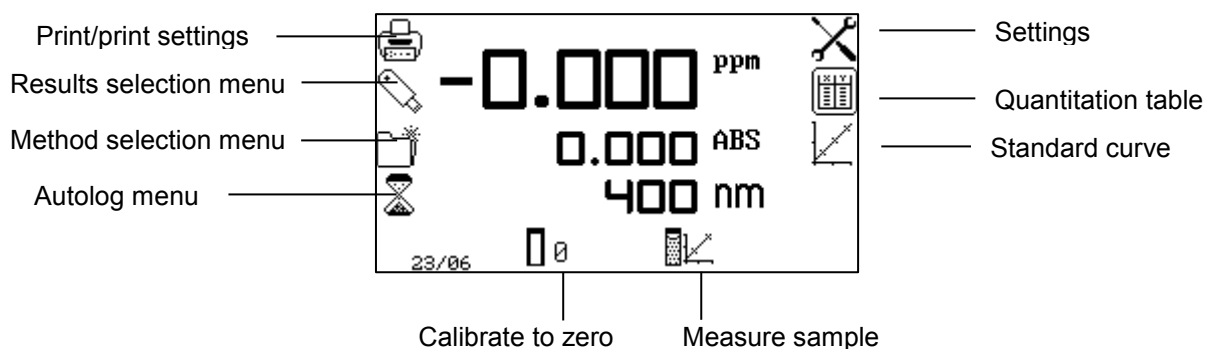
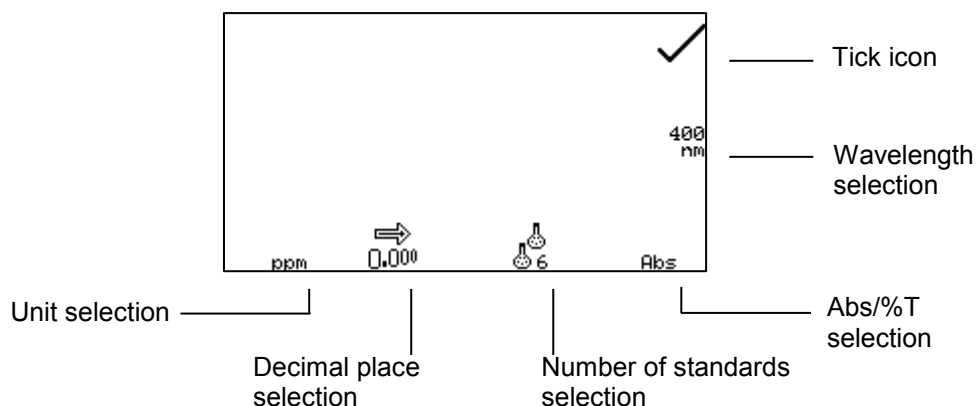

Fig 8.1 - Operating Menu

فروشگاه تجهیزات آزمایشگاهی روناکو

## 8.2 METHOD SETUP

### 8.2.1 Selecting a Wavelength



**Figure 8.2.1 – Settings menu**

The wavelength can be changed by entering the settings menu and using the key adjacent to the wavelength selection icon (as per figure 8.2.1).

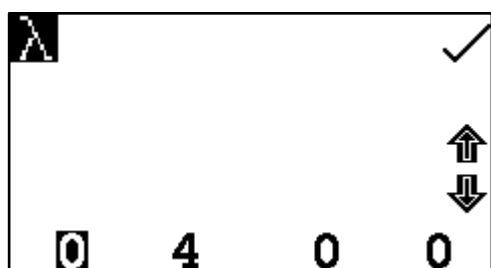

Pressing the wavelength selection key opens the number entry screen. Use the keys at the bottom of the screen to select the digit to be changed and use the keys adjacent to the arrow icons to increase or decrease the number. Press the key adjacent to the tick icon to save and return to the settings menu.

The wavelength selected should be the same wavelength the new standards and unknown samples are to be measured at.

### 8.2.2 Selecting Number of Standards

ppm		Abs	✓
0.10	1	0.100	
0.20	2	0.200	
0.30	3	0.300	
	↓	6	📊

The number of standards used to create a standard curve can be changed from 2 to 6 standards. To change the number of standards press the key below the number of standards icon. Repeat presses cycles the number between 2, 3, 4, 5 and 6. If there is only one standard available the concentration measurement mode should be used.

The standard curve can also be viewed from this screen by pressing the key adjacent to the standard curve icon.

### 8.2.3 Selecting Concentration Units

The units of concentration can be selected from a number of options: no units, %, ppm, EBC, SRM, mEq/l, mEq, M, mM, μM, nM, U, U/l, U/ml, g/l, mg/l, μg/l, ng/l, g/dl, mg/dl, μg/dl, mg/ml, μg/ml, ng/ml, μg/μl, ng/μl, mol/l, mmol/l.

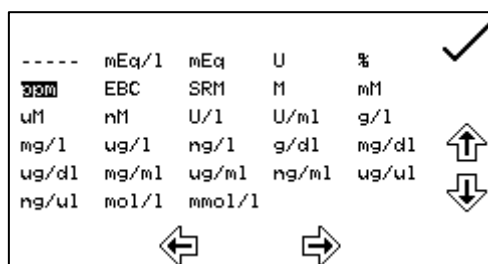

In the settings menu press the key below the units icon and use the keys adjacent to the arrow icons to navigate round the screen to select the required units. Once the required units have been selected press the key adjacent to the tick icon to save and return to the settings menu.

### 8.2.4 Changing the Resolution

The resolution of the concentration can be selected from 1, 0.1, 0.01 or 0.001 by repeat presses of the key below the resolution icon in the settings menu.

### 8.2.5 Selecting Absorbance or % Transmittance

The operating mode can be changed between absorbance or % transmittance by pressing the key below the Abs or %T icon in the settings menu. Repeat presses will cycle between absorbance or % transmittance.

## 8.3 Quantitation Table

The quantitation table enables the quantitation standards to be viewed, modified and measured. This function also enables the number of standards to be set. To access the quantitation table screen press the key adjacent to the quantitation table icon in the operating menu.

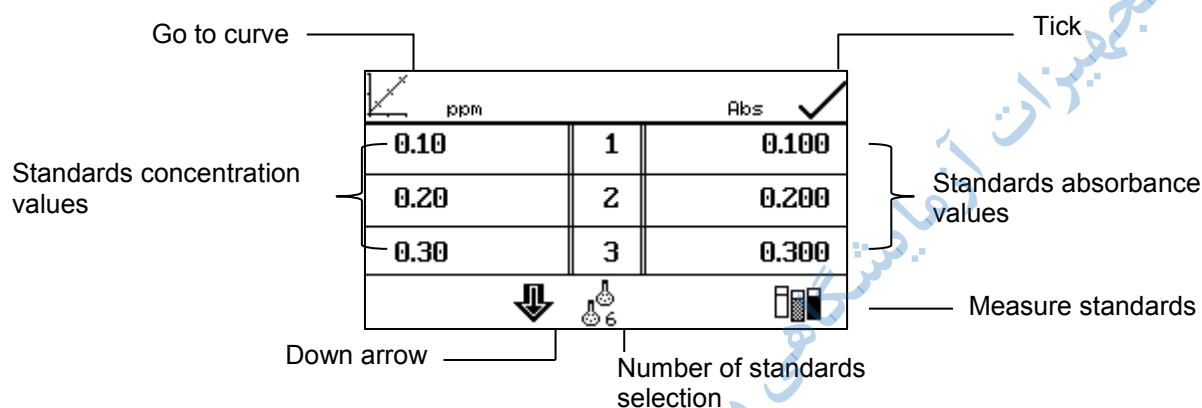





Figure 8.3.1 – Quantitation table menu

Only three standards can be displayed on the screen at one time; to view the other standards in the table press the key below the down arrow icon. The quantitation table displays the standard



concentration on the left hand side of the table with the corresponding absorbance or % transmittance on the right hand side.

### 8.3.1 Modifying Standards

ppm		Abs
0.10	1	0.100
0.20	2	0.200
0.30	3	0.300
 		

This function enables standards to be added which will be used to create the standard curve. Before creating a new standard curve the concentrations of the standards to be measured must be entered here. To enter the concentration of the first standard press the key adjacent to the first concentration in the table.

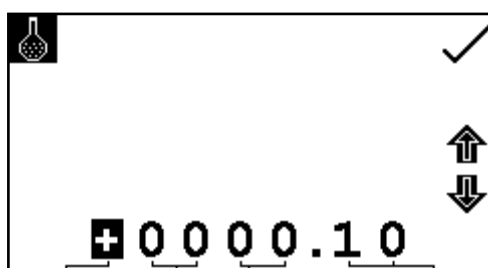

This opens a number entry screen; use the keys at the bottom of the screen to select the digit to be changed and use the keys adjacent to the arrow icons to increase or decrease the number. Once the required number has been entered press the key adjacent to the tick icon to save the changes.

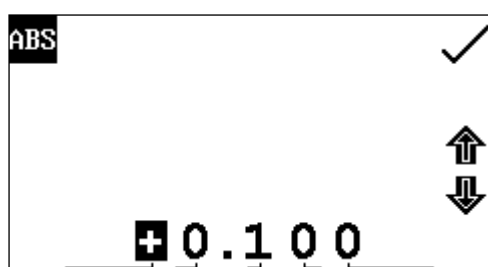

The photometric values of the standards can also be entered if known. To enter the photometric value press the key adjacent to the photometric value in the table that corresponds to the relevant concentration; this opens the number entry screen. Use the keys at the bottom of the screen to select the digit to be changed

and use the keys adjacent to the arrow icons to increase or decrease the number. The positive sign can be changed to a negative sign by pressing the key below the + icon. Once the required number has been entered press the key adjacent to the tick icon to save. When the required number of standards and standard concentrations have been set press the key below the measure standards icon (see fig 8.3.1) to measure standards.

فروشگاه تخصصی آزمون‌های روناکو

## 8.4 STANDARD CURVE

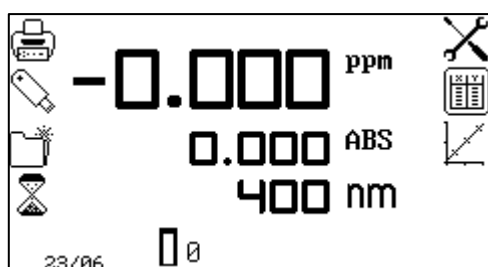

This function enables the current standard curve to be viewed, a new standard curve to be created, the curve fit to be adjusted and the curve statistics to be displayed. To access this function press the key adjacent to the standard curve icon in the operating menu.

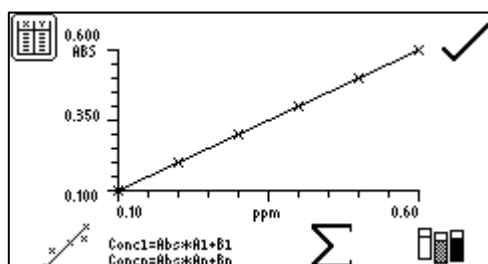

When the current standard curve is displayed the concentration and photometric value of the last sample measured is also displayed on the curve. The curve fit algorithm can be changed by pressing the key below the curve fit icon. Repeat presses of the key cycles the curve fit between linear, linear through zero, quadratic, quadratic through zero and interpolate.

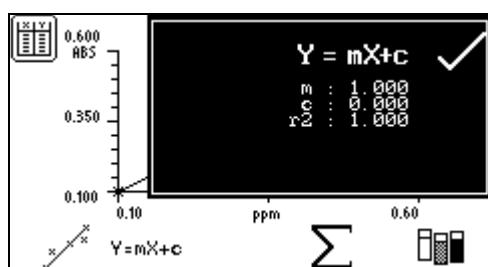

The curve statistics can also be displayed by pressing the key below the  $\Sigma$  icon; this opens a screen on top of the existing curve displaying statistics for the curve fit chosen. For example if the curve fit is  $y = mx+c$  the curve statistics displayed will be the gradient of the line ( $m$ ), constant ( $c$ ) and correlation coefficient ( $r^2$ ). To exit

this screen press the key adjacent to the tick icon. The quantitation table can also be viewed from this screen by pressing the key adjacent to the quantitation table icon.

### 8.4.1 Creating a New Standard Curve

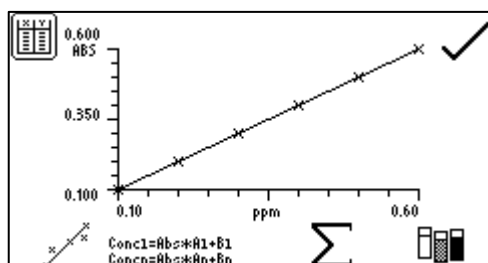

Before creating a new curve it is necessary to enter the concentrations of the standard solutions in the quantitation table. Also the number of standards should be selected in the quantitation table menu. A new standard curve can be created by pressing the key below the measure standards icon.

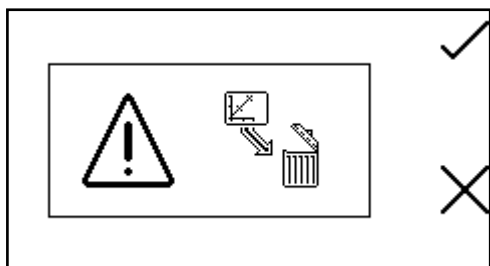

Confirmation will be needed to delete the old curve before a new one can be created. Press the key adjacent to the cross icon to cancel deletion and return to the current standard curve screen. Press the key adjacent to the tick icon to confirm deletion of the current standard curve and create a new curve.

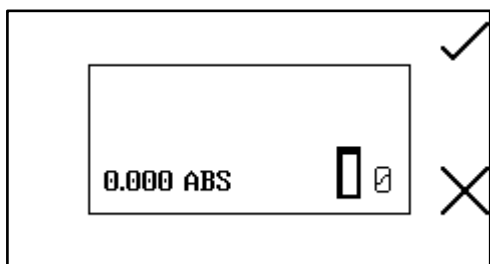

This will open the standard measurement screen. The first sample to be measured should be a blank sample as this will be used to calibrate the instrument to zero absorbance. Place the cuvette containing the blank solution into the sample chamber and close the instrument lid. Press the key adjacent to the tick icon to

perform an initial calibration to zero absorbance. Once this measurement has been performed the standard concentration samples can be measured. Remove the cuvette containing the blank solution from the sample chamber and insert the cuvette containing the first standardised solution to be

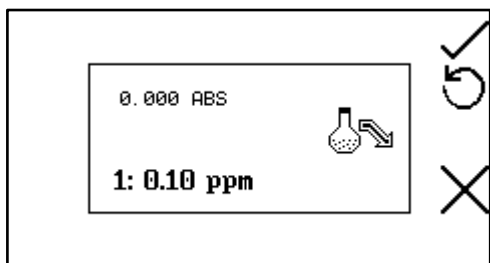

measured. Close the instrument lid and press the key adjacent to the tick icon to take a reading of the standard. The concentration along with the photometric value will then be displayed. This standard can be re-measured by pressing the key adjacent to the back icon.

To measure the next standard remove the current standard from the sample chamber and insert the cuvette containing the second standardised solution. Press the key adjacent to the tick icon to take a reading of the standard. Repeat this procedure until all the standards (up to a maximum of six) have been measured. Once all the standards have been measured the instrument returns to the standard curve screen and the new curve can be viewed. The photometric values for all of the newly added standards can be viewed in the quantitation table.

To abort creation of the new standard curve before all the standards have been measured press the key adjacent to the cross icon at any time and the instrument will return to the previous standard curve.

Once the curve has been created press the key adjacent to the tick icon and the screen will return to the operating menu where unknown samples can be measured. When this measurement mode is exited the current standard curve will be saved until it is replaced by a new curve.

The automatic 8 cell turret can be used to assist creating a new curve. Refer to section 11.3.1.

## 8.5 CALIBRATION

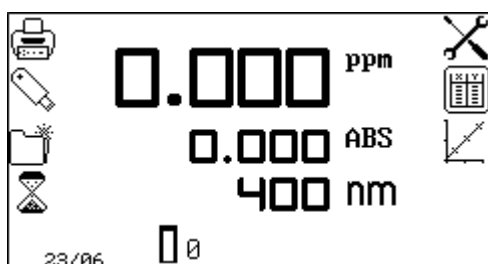

The zero calibration must be performed at the same wavelength as the standards were measured at and the unknown samples will be measured at. Insert a cuvette containing the blank solution into the sample chamber and close the instrument lid. Press the key below the calibrate to zero absorbance icon. The instrument will

calibrate to zero absorbance. Once the calibration is complete the measure sample icon appears and the sample can be measured. If the wavelength is adjusted before a sample is measured the measure sample icon will disappear and the instrument must be calibrated again at the new wavelength.

## 8.6 SAMPLE MEASUREMENT

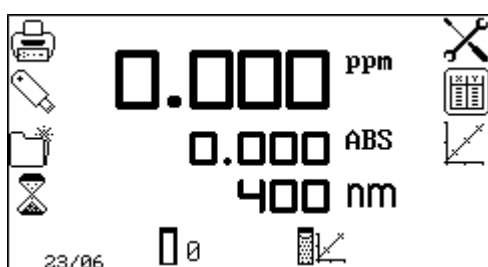

Once a calibration has been performed the measure sample icon appears. A standard curve should either be created or loaded from a previously saved method before carrying out a measurement of an unknown sample. Place the cuvette containing the sample in the sample chamber and close the instrument lid.

Press the key below the measure sample icon and the instrument will take a reading and the concentration and photometric values will be displayed on the screen. To view the position of this sample on the standard curve open the standard curve screen.

## 8.7 DATA ANALYSIS

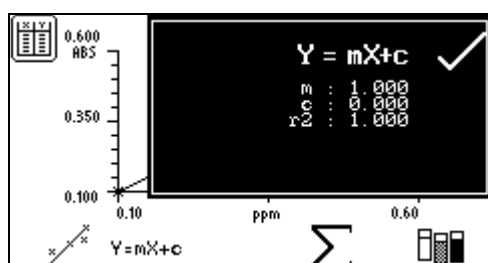

In quantitation the data analysis examines the statistics of the standard curve and algorithm of the curve fit. The curve statistics function is accessed by pressing the key below the  $\Sigma$  icon in the quantitation curve menu. The algorithm of the curve fit can be changed by pressing the key below the curve fit icon.

## 8.8 POST MEASUREMENT OPTIONS

Post measurement changes to the selected concentration units and the quantitation table values are restricted.

### 8.8.1 Changing Concentration Units

Users can adjust the displayed concentration unit after a measurement. If the measurements concentration unit is updated, the instrument will adjust the displayed concentration value to reflect the new selection. This functionality is limited to ensure that the user can only update the measurement unit to one that is a direct conversion from the original measurement unit. These restrictions are summarized in Table 8.7.1, where the selectable measurement units are grouped according to those which are interchangeable after a measurement.

Interchangeable Measurement Units								
1	2	3	4	5	6	7	8	9
%	EBC	mEq/l	mEq	M	U	U/l	g/l	mol/l
ppm	SRM			mM		U/ml	mg/l	mmol/l
				uM			ug/l	
				nM			ng/l	
							g/dl	
							mg/dl	
							ug/dl	
							mg/ml	
							ug/ml	
							ng/ml	
							ug/ul	
							ng/ul	

Table 8.8.1 – Post Measurement Unit Change Restrictions

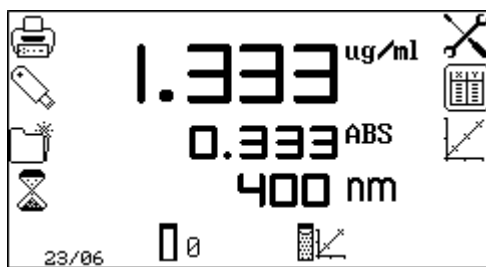

Once a measurement is complete, press the key adjacent to the settings icon, then press the key below the units icon. This will either cycle through the available unit options or open the units selection page.

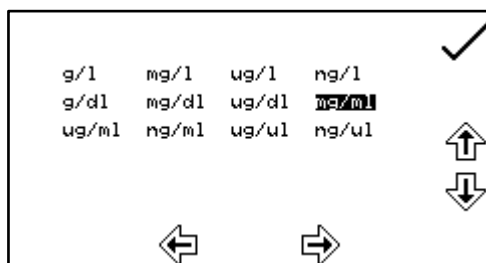

In the units selection page, select the updated measurement unit from the available options and press the key adjacent to the tick icon to confirm.

فروشگاه تجهیزات آزمایشگاهی روناکو

ppm		Abs
1.10e-3	1	0.100
1.20e-3	2	0.200
1.30e-3	3	0.300

In the quantitation table menu, the calibration standard values are updated.



The updated concentration value and measurement units are shown in the main display.

### 8.8.2 Changing the Quantitation Table Values

Users cannot adjust the quantitation table values once a blank measurement is performed. If the quantitation table values need to be changed, the user must exit and re-enter the quantitation measurement mode.

فروشگاه تجهیزات آزمایشگاهی روناکو

## SECTION 9 – KINETICS

The kinetics measurement mode enables the absorbance or % transmittance of an active molecule to be measured over a period of time; for example enzyme analysis of horseradish peroxidase. The absorbance or % transmittance is measured at regular time intervals at a set wavelength over a period of time. The results are plotted on a graph to show the change in absorbance or % transmittance over time. Following sample measurement statistical analysis of all or part of the experiment can be performed.

### 9.1 MODE SPECIFIC PARAMETERS

The kinetics operating menu enables measurement parameters to be changed. The utility toolbar on the left hand side of the screen enables access to printing, print setup options, results, methods and autologging options. For more details on the different functions of the utility toolbar refer to section 10.

The settings icon enables the wavelength, units, resolution, graph y-axis, absorbance or % transmittance operating mode, standard, factor, measurement time, lag time and start on level to be set. Following the completion of a set of kinetics measurements the statistics for all or part of the kinetics run can be analysed. The kinetics moving line function enables the initial and final points of the curve to be selected, so that analysis of the area between these two points can be performed.

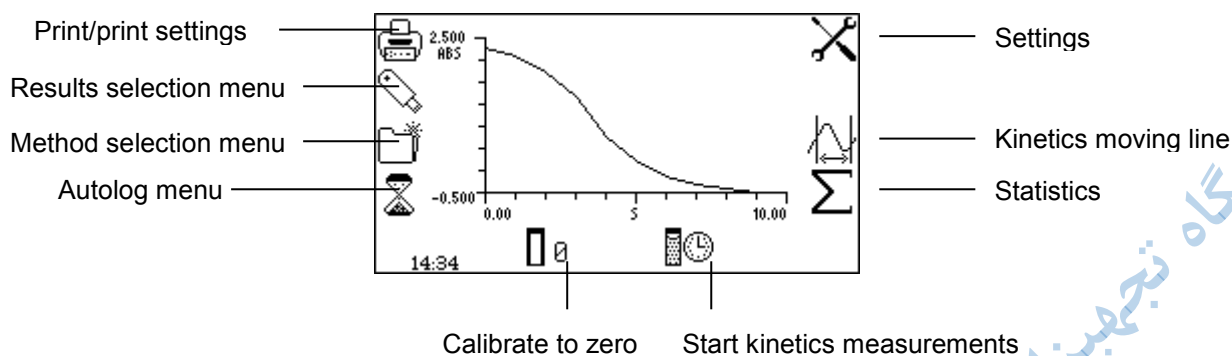

**Fig 9.1 - Operating Menu – Post Measurement**

فروشگاه تجهیزات آزمایشگاهی روناکو

## 9.2 METHOD SET UP

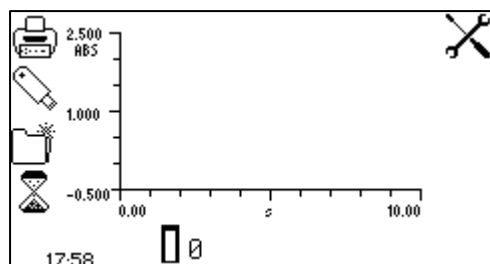

In this measurement mode all the method set up parameters are accessed through the settings menu. To open the settings menu press the key adjacent to the settings icon in the operating menu.

### 9.2.1 Kinetics Settings

The settings menu enables the wavelength, units, resolution, graph y-axis, operating mode, standard, factor, measurement time, lag time and start on level to be set. Once all of the required settings have been entered press the key adjacent to the tick icon to save and return to the operating menu.

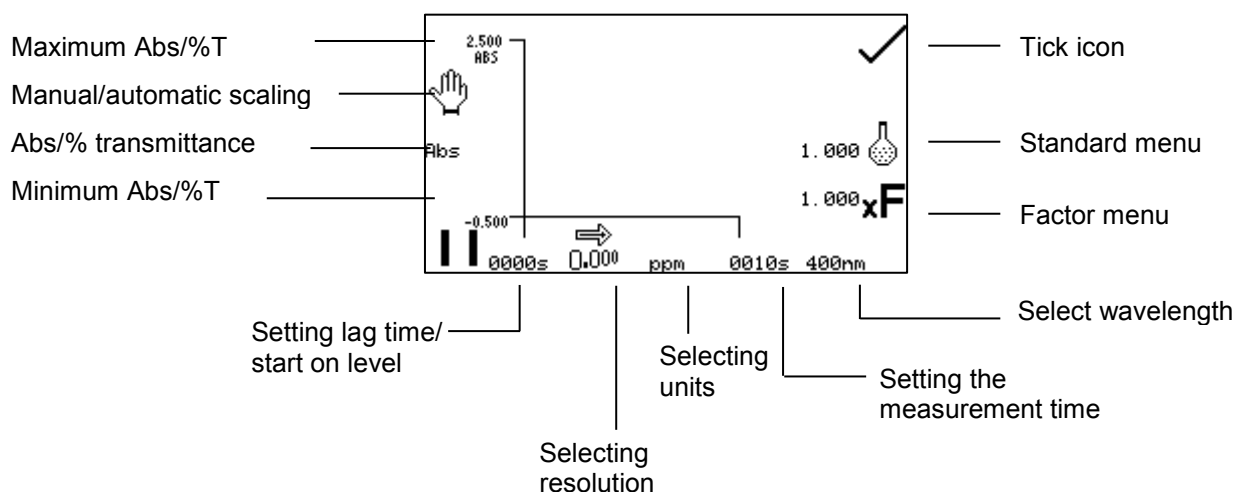
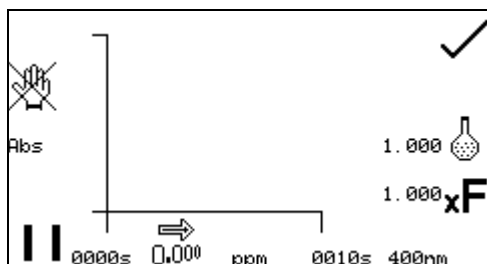

Fig 9.2.1 - Settings Menu

#### 9.2.1.1 Y-Axis Scaling

This function enables the scale of the y-axis of the kinetics graph to be adjusted either manually or automatically. The automatic scaling is represented by the hand icon with a cross through it and the manual scaling by the hand icon without the cross. To select manual or automatic scaling press the key adjacent to the hand icon. Repeat pressing of the key cycles between manual and automatic scaling.





**Automatic Scaling**

In automatic y-axis scaling the absorbance or % transmittance values are cleared from the settings screen. When the kinetics measurement is complete the y-axis is automatically re-scaled.

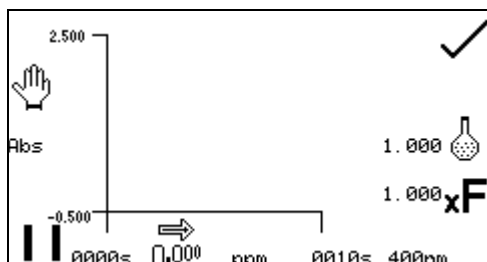

**Manual Scaling**

In manual scaling the minimum and maximum absorbance or % transmittance values can be set. To change the absorbance or % transmittance values press the key adjacent to the minimum y-axis value, this opens a number entry screen.

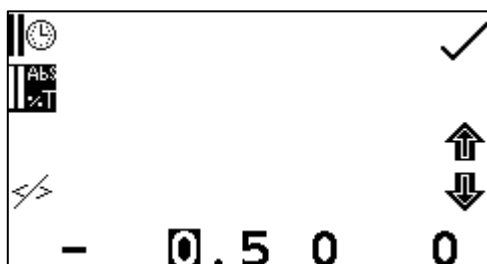

Use the keys at the bottom of the screen to select the digit to be changed and use the keys adjacent to the arrow icons to increase or decrease the number. To change the sign press the key below the + or - icon. Repeat presses will cycle between + and -. Once the required absorbance or % transmittance value has been entered press the key adjacent to the tick icon.

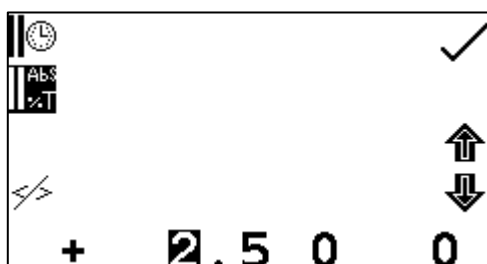

To change the maximum absorbance or % transmittance value press the key adjacent to the maximum y-axis value and this opens a number entry screen. Use the keys adjacent to the arrow icons to increase or decrease the number. To change the sign press the key below the + or - icon. Repeat presses will

cycle between + and -. Once the required absorbance or % transmittance has been entered press the key adjacent to the tick icon.

### 9.2.1.2 Setting Lag Time or Start on Level

In this measurement mode starting the kinetics measurements can be delayed by setting a lag time or a start on level. The lag time is the amount of time that the instrument will wait before starting the kinetics measurements. The start on level is the absorbance level that must be reached before starting the kinetics measurements. Both options can be set using the set lag

time/start on menu. This function is accessed by pressing the key below the start time pause icon on the far left side of the x-axis. This opens the lag time/start on level menu.

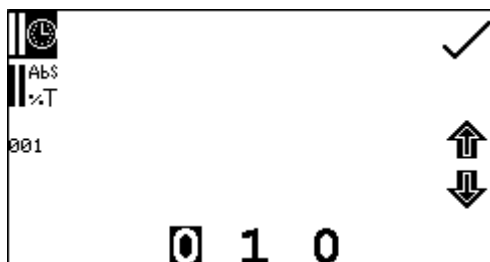

To set the lag time press the key adjacent to the clock icon. Use the keys at the bottom of the screen to select the digit to be changed and the keys adjacent to the arrow icons to increase or decrease the number. The lag time can be reset to one by pressing the key adjacent to the 001 icon.

Once the required lag time has been entered in seconds press the key adjacent to the tick icon to save and return to the settings menu.

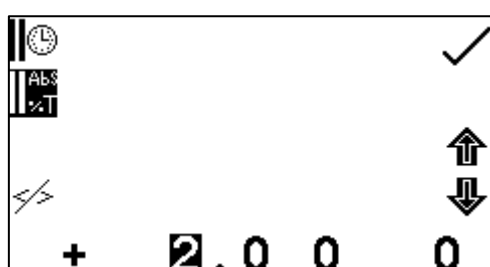

To set the start on level press the key adjacent to the Abs/%T icon. Use the keys at the bottom of the screen to select the digit to be changed and the keys adjacent to the arrow icons to increase or decrease the number. The positive sign can be changed to a negative sign by pressing the key below the symbol + icon.

On the left hand side of the screen the symbol can be changed to read greater than (>) or less than (<) the absorbance level that has been entered. The start on level can also be turned off (</>). Once the required absorbance or % transmittance level (depending on the operating mode selected) has been entered press the key adjacent to the tick icon to save and return to the settings menu.

### 9.2.1.3 Selecting Absorbance or % Transmittance

The operating mode is displayed on the left hand side of the screen. The default parameter is absorbance and pressing the key adjacent to the ABS icon cycles the operating mode between the absorbance or % transmittance.

### 9.2.1.4 Changing the Resolution

The resolution of the concentration can be selected from 1, 0.1, 0.01 or 0.001 by repeat presses of the key below the resolution icon.

### 9.2.1.5 Selecting Concentration Units

The concentration units can be selected from a number of options: no units, %, ppm, EBC, SRM, mEq/l, mEq, M, mM,  $\mu$ M, nM, U, U/l, U/ml, g/l, mg/l,  $\mu$ g/l, g/dl, mg/dl,  $\mu$ g/dl, mg/ml,  $\mu$ g/ml, ng/ml,  $\mu$ g/ $\mu$ l, ng/ $\mu$ l, mol/l, mmol/l.

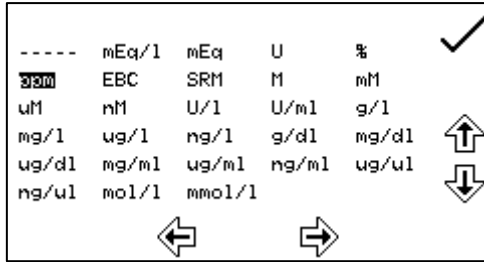

In the settings menu press the key below the units icon to open the unit selection screen which displays all the different unit options. Use the keys adjacent to the arrow icons to navigate around the screen to select the required units. Once the required units have been highlighted press the key adjacent to the tick icon to save and return to the settings menu.

### 9.2.1.6 Using a Standard

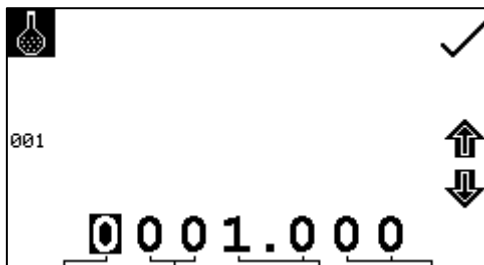

The standard menu enables the value for a standard to be entered. This function is accessed by pressing the key adjacent to the standard icon. This opens the extended number entry screen. Use the keys at the bottom of the screen to select the digit to be changed. The key below the digit must be pressed twice to select

the adjacent digit. For example 00, the first press of the key alters 10, the second press alters 01. Use the keys adjacent to the arrow icons to increase or decrease the selected number. Standard values of 0.001 to 1000 can be entered. The standard value can be reset to one by pressing the key adjacent to the 001 icon. Once the standard value has been entered press the key adjacent to the tick icon to save and return to the settings menu screen. The entered value is now displayed in the settings menu adjacent to the standard icon.

A standard value should only be entered if the factor is not known. If the factor is known the standard value should be set to 1.000.

### 9.2.1.7 Using a Factor

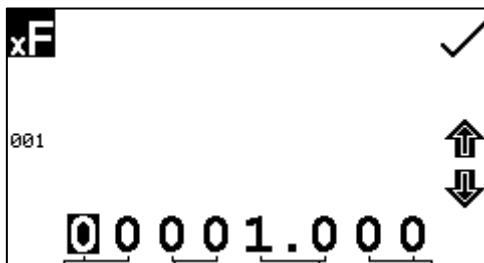

The factor menu enables a factor to be entered. This function is accessed by pressing the key adjacent to the factor icon. This opens the extended number entry screen. Use the keys at the bottom of the screen to select the digit to be changed. The key below the digit must be pressed twice to select the adjacent digit.

For example 00, the first press of the key alters 10, the second press alters 01. Use the keys adjacent to the arrow icons to increase or decrease the selected number. Factor values of 0.001 to 10,000 can be entered. The factor value can be reset to one by pressing the key adjacent to the 001 icon. Once the factor has been entered press the key adjacent to the tick icon to save and

return to the settings menu screen. The entered value is now displayed in the settings menu adjacent to the factor icon.

If the factor is not known a standard should be measured in order to calculate the factor. If a standard is used the factor value should be set to 1.000.

### 9.2.1.8 Selecting a Wavelength

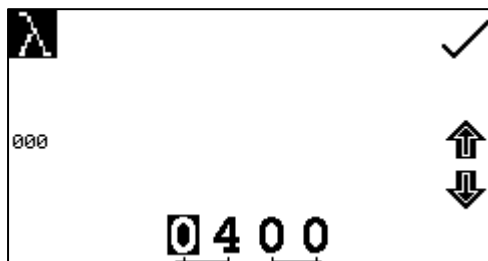

To adjust the wavelength press the key adjacent to the wavelength icon. This will open the number entry screen. Use the keys at the bottom of the screen to select the digit to be changed and the keys adjacent to the arrow icons to increase or decrease the number. Once the required wavelength has been entered press

the key adjacent to the tick icon to save the changes and return to the settings menu screen.

### 9.2.1.9 Setting the Kinetics Measurement Time

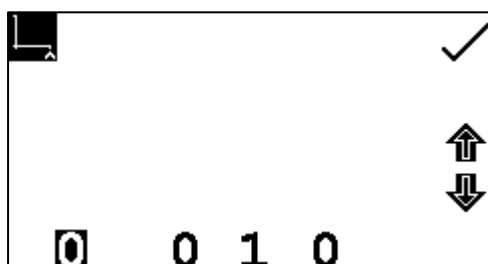

This function enables the measurement time for the kinetics scan to be set. To access this function press the key below the time displayed on the far right of the x-axis; this will open a number entry screen. Use the keys at the bottom of the screen to select the digit to be changed and use the keys adjacent to the arrow icons

to increase or decrease the number. Once the required measurement time in seconds has been entered press the key adjacent to the tick icon to save and return to the settings menu.

## 9.3 CALIBRATION

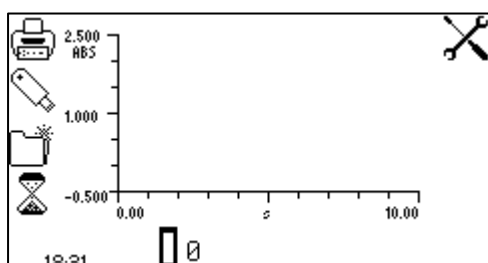

The calibration must be performed at the same wavelength at which the sample will be measured. Insert a cuvette containing the blank solution into the sample chamber and close the instrument lid. Press the key below the calibrate to zero absorbance icon. The instrument will calibrate to 0.00 absorbance.

Once the calibration is complete the start kinetics measurement icon will be displayed and a sample can be measured. If the wavelength is adjusted before the sample is measured the start kinetics measurements icon will disappear and the instrument must be calibrated again at the new wavelength.

## 9.4 SAMPLE MEASUREMENT

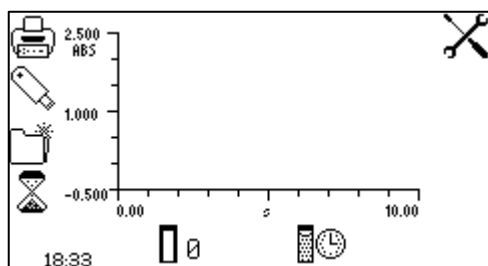

Insert a cuvette containing the sample to be analysed into the sample chamber and press the key below the start kinetics measurements icon. If a start on level or lag time has not been set the instrument begins taking a photometric reading every second. As each reading is taken it is plotted on the graph.

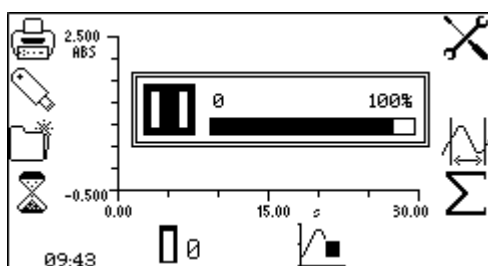

If a lag time has been set a progress bar will be displayed showing the lag time counting down. Once the lag time is complete the instrument will begin taking readings.

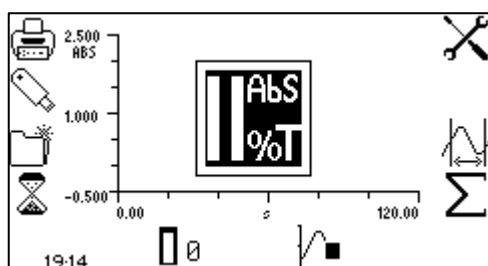

If a start on level has been set the Abs/%T icon is displayed in the centre of the screen. The instrument will take photometric readings until the start on level is reached. Once the absorbance/% transmittance level has been reached the readings will be plotted on the graph.

Once the measurement has commenced it can be aborted by pressing the key below the kinetics measurement in progress icon.

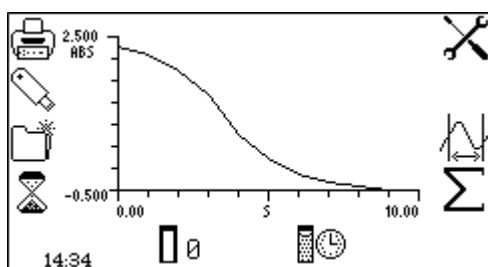

Depending on how many data points have been recorded, the instrument will either return to the pre-measurement screen or display a partial scan.

Once the measurement time is reached the experiment is complete and the post measurement icons are displayed. If the automatic scaling was selected the y-axis will automatically be re-scaled.

## 9.5 DATA ANALYSIS

Following the completion of the kinetics measurements the post measurement icons are displayed on the screen. These include the statistics for the kinetics experiment and the kinetics

moving line. The post measurement statistics include rate of change, start and end absorbance levels and concentration of the sample. The kinetics moving line function enables the initial and final points of the experiment to be set and the statistics for this part of the experiment to be analysed.

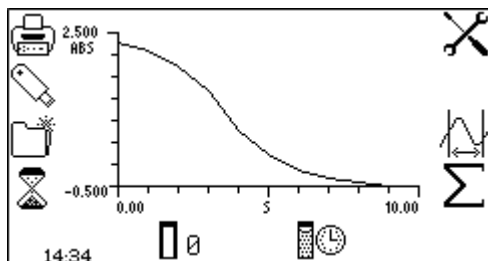

To access the statistics for the whole of the kinetics experiment press the key adjacent to the  $\Sigma$  icon which opens the statistics menu over the top of the operating menu.

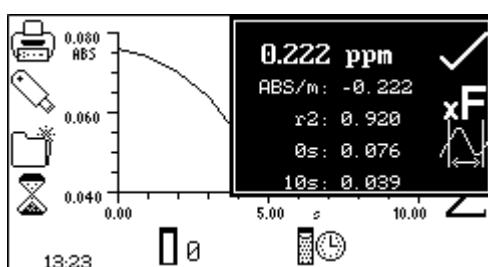

The information displayed includes concentration, absorbance per minute (rate of change), correlation coefficient ( $r^2$ ), start time absorbance and end time absorbance. If the operating mode selected was % transmittance then the statistics displayed will be % transmittance instead of absorbance.

In this menu the factor can be updated by pressing the key adjacent to the factor icon. The instrument calculates the factor and saves the value in the settings. Therefore the factor value calculated can be used in subsequent measurements to calculate the concentration of unknown samples.

To exit the statistics menu press the key adjacent to the tick icon.

The kinetics moving line screen can also be accessed from this menu by pressing the key adjacent to the kinetics moving line icon. The kinetics moving line function enables the initial and final points of the kinetics experiment to be set, allowing the statistics for this part of the experiment to be analysed specifically. This function can be accessed from the statistics menu or from the operating menu by pressing the key adjacent to the kinetics moving line icon.

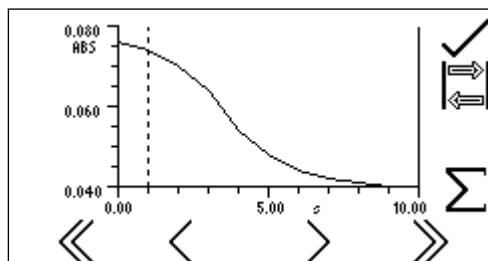

In the kinetics moving line screen the initial and final time lines appear as two vertical lines. The line which is selected is represented by a dashed line --- and can be moved using the keys below the greater than (>) or less than (<) icons at the bottom of the screen.

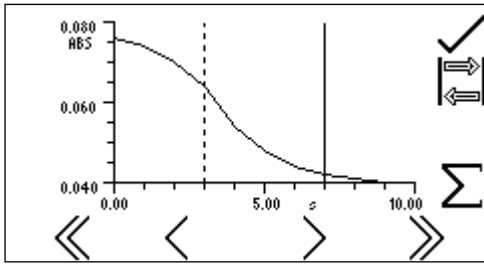

Move the dashed line to the point on the x-axis which is to be the initial time. To select the final time press the key adjacent to the toggle icon. This will change the initial line from a dashed line to a solid line. The final time line will change from a solid line to a dashed line. Use the keys below the greater than (>) or less than (<) icons to move the line to the final time on the x-axis by reducing or increasing in 1 second time intervals.

The double greater than (>>) or double less than (<<) icons move the line in 5 second time intervals.

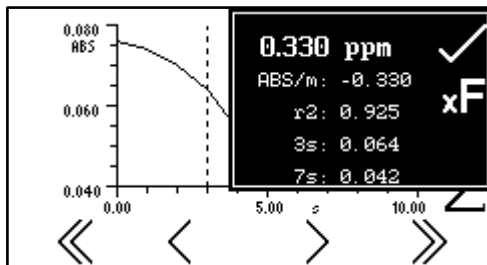

Once the required initial and final times have been selected press the key adjacent to the  $\Sigma$  icon to display the statistics menu for that portion of the experiment. The information displayed includes concentration, absorbance per minute (rate of change), correlation coefficient ( $r^2$ ), start time absorbance and end time

absorbance. If the operating mode selected was % transmittance then the statistics will be % transmittance instead of absorbance. To exit the statistics menu press the key adjacent to the tick icon.

## 9.6 POST MEASUREMENT OPTIONS

Post measurement changes to the selected concentration units the calibration standard and concentration factor values are restricted.

### 9.6.1 Changing Concentration Units

Users can adjust the displayed concentration unit after a measurement. If the measurements concentration unit is updated, the instrument will adjust the displayed concentration value to reflect the new selection. This functionality is limited to ensure that the user can only update the measurement unit to one that is a direct conversion from the original measurement unit. These restrictions are summarized in Table 9.6.1, where the selectable measurement units are grouped according to those which are interchangeable after a measurement.

فروشگاه تجهیزات آزمایشگاهی روناکو

Interchangeable Measurement Units								
1	2	3	4	5	6	7	8	9
%	EBC	mEq/l	mEq	M	U	U/l	g/l	mol/l
ppm	SRM			mM		U/ml	mg/l	mmol/l
				uM			ug/l	
				nM			ng/l	
							g/dl	
							mg/dl	
							ug/dl	
							mg/ml	
							ug/ml	
							ng/ml	
							ug/ul	
							ng/ul	

Table 9.6.1 – Post Measurement Unit Change Restrictions

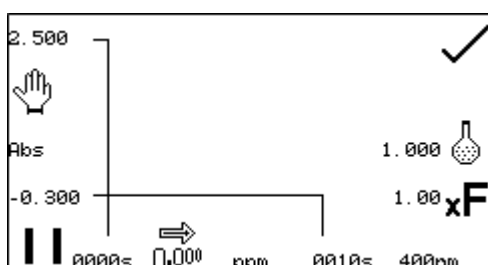

Once a measurement is complete, press the key adjacent to the kinetics settings icon, then press the key below the unit's icon. This will either cycle through the available unit options or open the unit's selection page.

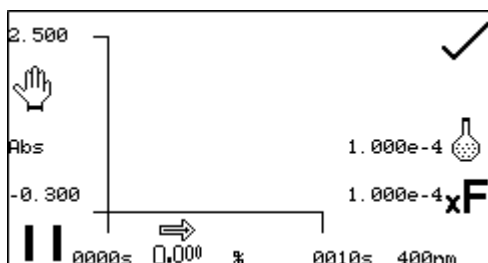

In the kinetics settings menu, the calibration standard and concentration factor values are updated.

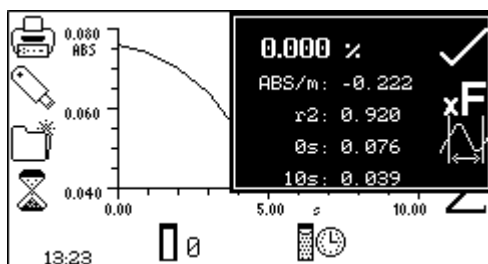

The updated concentration value and measurement unit are shown in the kinetics statistics screen.

فروشگاه تجهیزات آزمایشگاهی روناکو



### **9.6.2 Changing the Concentration Factor**

Users cannot adjust the concentration factor once a blank measurement is performed. If the concentration factor needs to be changed, the user must exit and re-enter the kinetics measurement mode.

### **9.6.3 Changing the Calibration Standard Value**

Users cannot adjust the calibration standard value once a blank measurement is performed. If the calibration standard value needs to be changed, the user must exit and re-enter the kinetics measurement mode.

فروشگاه تجهیزات آزمایشگاهی روناکو

## SECTION 10 – SAVING, PRINTING AND AUTOLOGGING

The utility toolbar in the operating menu provides access to printing, print setup options, opening, saving and deleting results and methods and autologging options.

If the method lock has been activated the method selection menu is disabled.

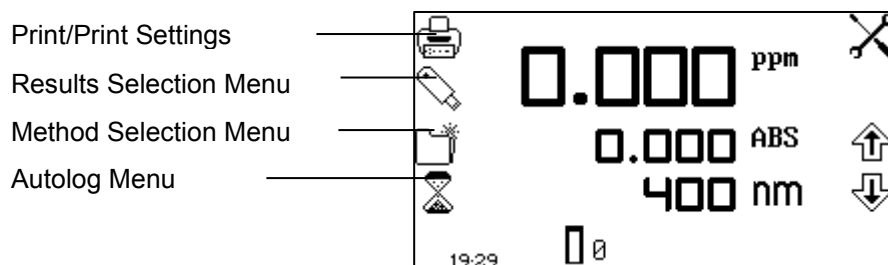
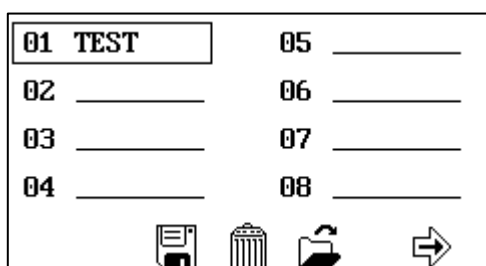

Fig 10.1 - Operating Menu

### 10.1 SAVING METHODS

Up to 48 methods can be saved in each of the measurement modes to the internal memory of the instrument. Once the method has been saved to the internal memory the method can be saved directly to a USB memory stick and opened on another instrument.

#### 10.1.1 SAVING METHODS TO INTERNAL MEMORY



In the operating menu press the key adjacent to the method icon to open the method selection menu. Select the location to save the method by pressing the key adjacent to the location. Use the keys below the arrow icons to move page up or down. Press the key below the save method icon to open the method naming menu.



The default method name will be displayed. To save the method under the default name press the key adjacent to the tick icon. To change the name of the method press the key below the eraser icon. One press of the key will delete one letter, holding the key for 2 seconds will delete the name completely.

To select letters use the keys adjacent to the arrow icons to move around the menu. Once the required letter is highlighted press the key below the pencil icon to select the letter. Up to eight characters can be selected. To change the letter case or to use numbers in the method name press the key below the AB icon. Repeat pressing of this key will cycle between upper case, lower

case and numbers. Once the required name for the method has been entered press the key adjacent to the tick icon to save the method and return to the method selection menu.

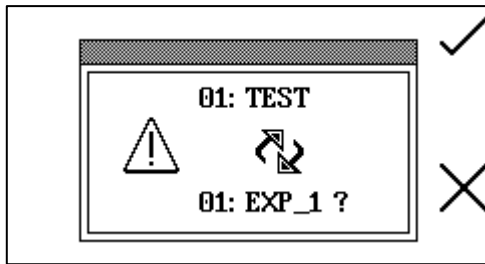

If there is already a method saved in the chosen location confirmation will be needed to replace the existing method with the new one; press the key adjacent to the tick icon to confirm replacement. Press the key adjacent to the cross icon to cancel and return to the method naming menu.

To exit the method naming menu without saving the method press the back key.

### 10.1.2 SAVING METHODS TO USB MEMORY STICK

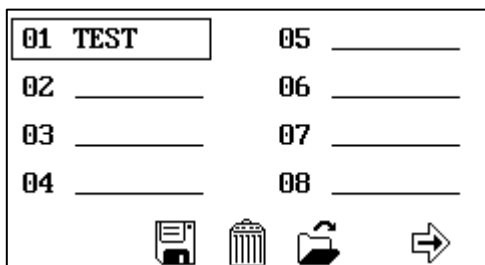

In the operating menu press the key adjacent to the method icon to open the method selection menu. Select the method to save to USB memory stick by pressing the key adjacent to the method location. Use the keys below the arrow icons to move page up or down. Hold the key below the

save method icon for 2 seconds to open the save to UBS memory stick menu.

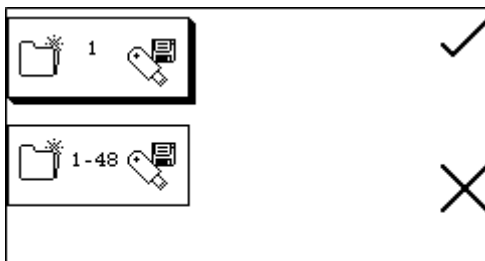

Either the single method selected or all 48 methods can be saved to USB memory stick. To save a single method press the key adjacent to the single method save icon. To save all 48 methods press the key adjacent to the 1 - 48 method save icon. Press the key adjacent to the tick icon to confirm saving the

method(s) to USB memory stick. Press the key adjacent to the cross icon to cancel saving the method(s) to USB memory stick and return to the method selection screen.

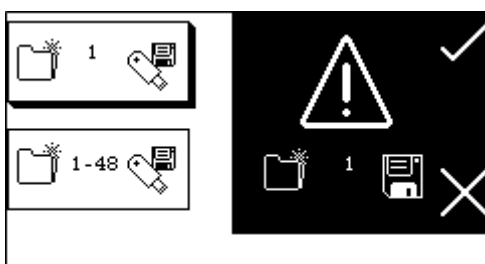

Confirmation will be needed to save the methods to USB memory stick. Press the key adjacent to the tick icon to confirm saving the method(s). Press the key adjacent to the cross icon to cancel and return to the option of saving one or all of the methods to USB memory stick.

## 10.2 OPENING METHODS

Methods can be opened from the internal memory of the instrument or from a USB memory stick. Before a method can be opened from a USB memory stick it must be saved to the internal memory of the instrument first.

### 10.2.1 OPENING METHODS FROM INTERNAL MEMORY

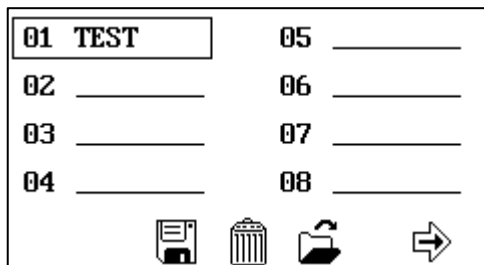

In the operating menu press the key adjacent to the method icon to open the method selection menu and use the keys below the arrow icons to move page up or down. Select the method to open by pressing the key adjacent to the method location. Press the key below the open method icon.

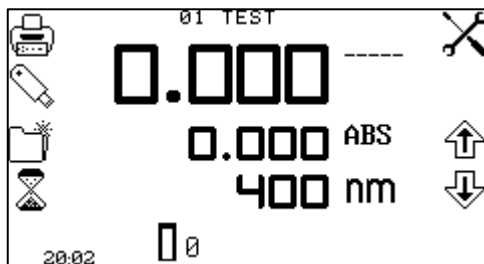

The instrument will return to the current measurement mode and the method name will be displayed at the top of the operating menu.

If a method hasn't been selected it is still possible to calibrate the instrument and take measurements. The instrument will operate in a generic method, 0, where all the current operating settings will be stored. There are separate method 0's for each measurement mode.

### 10.2.2 OPENING METHODS FROM USB MEMORY STICK

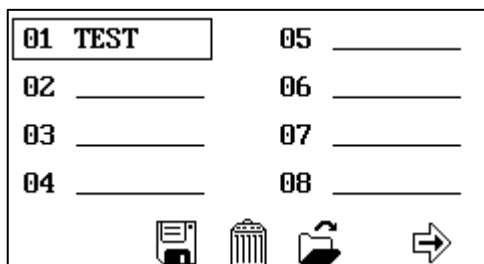

In the operating menu press the key adjacent to the method icon to open the method selection menu and use the keys below the arrow icons to move page up or down. Select an empty location to save the method by pressing the key adjacent to the location. Hold the key below the open method icon for 2 seconds.

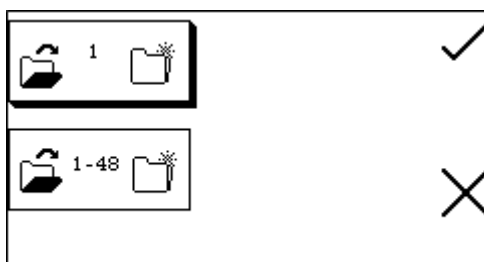

Either a single method or all 48 methods can be opened from the USB memory stick. Select one method by pressing the key adjacent to the single method open icon. To open all methods press the key adjacent to the 1 - 48 method open icon. Press the key adjacent to the tick icon to confirm

selection or press the key adjacent to the cross icon to cancel and return to the method selection screen.

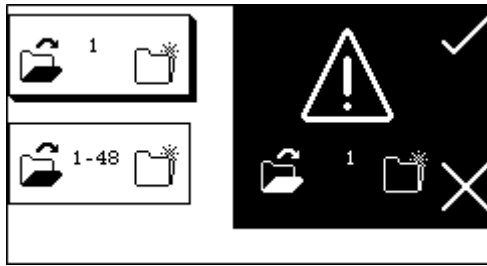

Confirmation will be needed to open the method(s) as any existing methods in this measurement mode will be overwritten. Press the key adjacent to the tick icon to save over the existing methods. Press the key adjacent to the cross icon to cancel and return to the option of opening one or all methods from the USB

memory stick. If a single method is selected to be opened, this method will be stored in the same location that it was saved in when it was saved to the USB memory stick.

### 10.3 DELETING METHODS

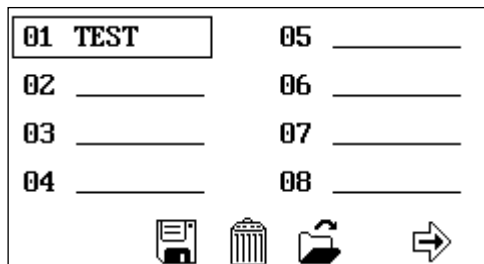

In the operating menu press the key adjacent to the method icon to open the method selection menu and use the keys adjacent to the arrow icons to move page up or down. Select the method to be deleted by pressing the key adjacent to the method location and press the key below the delete icon.

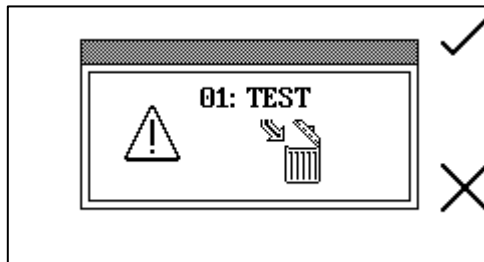

Confirmation will be needed to delete the selected method; press the key adjacent to the tick icon to confirm deletion. Press the key adjacent to the cross icon to cancel deletion and return to the method selection menu.

### 10.4 SAVING RESULTS

Results can only be saved to a USB memory stick if there is a valid USB memory stick inserted into the front of the instrument. The instruments are supplied with a USB memory stick but other types which may be used include: the PNY Attache Premium, the Emtec C250, The Kingston Data Traveler G2, the Sony Pocket Bit and the Integral Flexi.

فروشگاه تجهیزات آزمایشگاهی رونکو

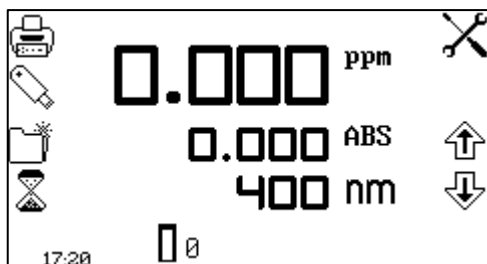

In the operating menu press the key adjacent to the USB memory stick icon to open the results selection menu.

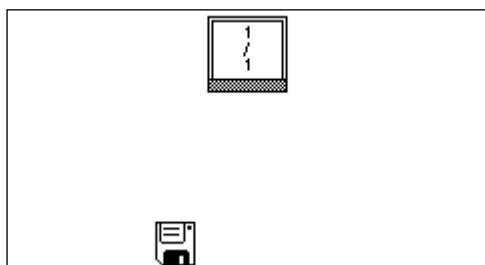

If the USB memory stick doesn't have any results stored on it only the save to USB memory stick icon will be displayed. To save a result press the key below the save to USB memory stick icon. This will open the results naming menu.



The default result name will be displayed. To save the result under the default name press the key adjacent to the tick icon. To change the name of the result press the key below the eraser icon. One press of the key will delete one letter, holding the key for 2 seconds will delete the name completely.

To select letters use the keys adjacent to the arrow icons to move around the menu. Once the required letter is highlighted press the key below the pencil icon to select the letter. Up to eight characters can be selected. To use numbers in the results name press the key below the AB icon. Repeat pressing of this key will cycle between upper case and numbers. Once the required name for the result has been entered press the key adjacent to the tick icon to save and return to the results selection menu.

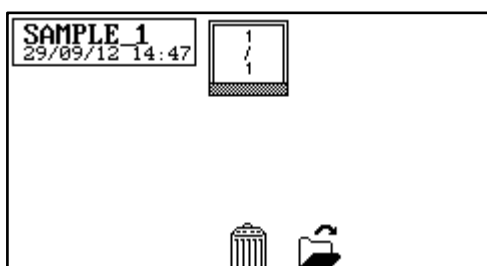

The saved results are listed alphabetically with the date and time that the result was generated.

If there is already a result saved under the same name confirmation will be needed to replace the existing result with the new one. Press the key adjacent to the tick icon to confirm replacement. Press the key adjacent to the cross icon to cancel and return to the results naming menu.

In photometrics, concentration and quantitation once a result has been saved to the USB memory stick the USB memory stick icon will remain highlighted. Pressing the key adjacent to the highlighted icon will result in subsequent results being saved under the same file name. To save

the result with a new filename hold the key adjacent to the highlighted USB memory stick icon for 2 seconds. This will open the results naming screen.

### 10.5 OPENING RESULTS

Results can only be opened if a valid USB memory stick is inserted into the front of the instrument.

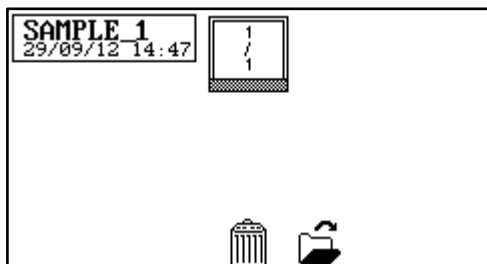

In the operating menu press the key adjacent to the USB memory stick icon to open the results selection menu. Select the result to be opened by pressing the key adjacent to the result. Press the key below the load from USB memory stick icon.

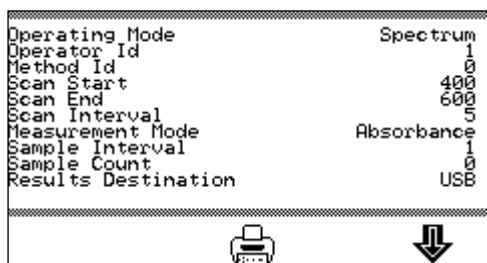

The result will be displayed on the screen. The information displayed is specific to the measurement mode which the result was generated and saved in. Use the keys below the arrow icons to display more information.

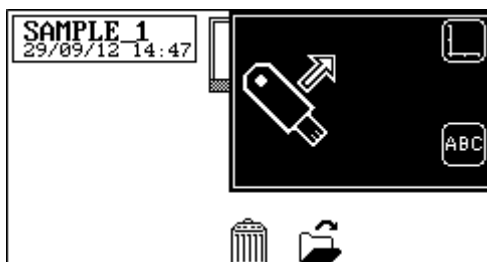

When opening a spectrum or kinetics result the result can be viewed graphically on an axis or as a text file. To view the result graphically press the key adjacent to the axis icon. To view the result as a text file press the key adjacent to the ABC icon.

### 10.6 DELETING RESULTS

Results can only be deleted if a valid USB memory stick is inserted into the front of the instrument.

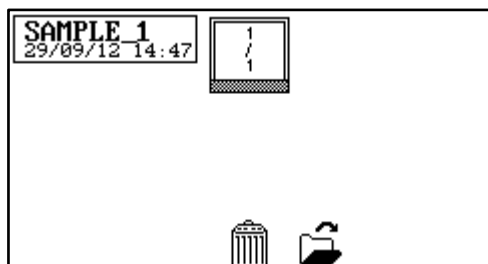

In the operating menu press the key adjacent to the USB memory stick icon to open the results selection menu. Select the result to be deleted by pressing the key adjacent to the result. Press the key below the delete icon.

فروشگاه تجهیزات آزمایشگاهی روناکو

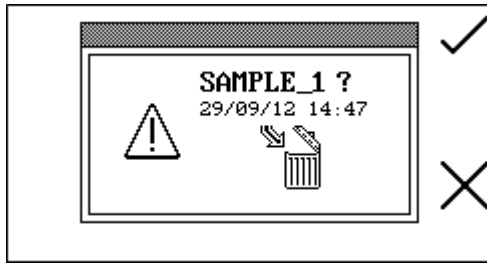

Confirmation will be needed to delete the selected result; press the key adjacent to the tick icon to confirm deletion. Press the key adjacent to the cross icon to cancel and return to the results selection menu.

## PRINTING

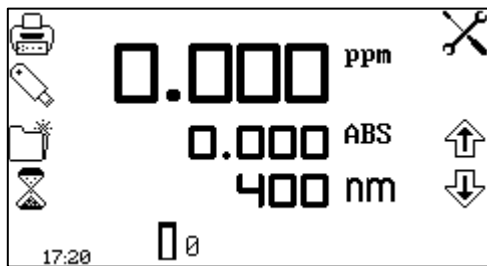

Operating Menu

The utility toolbar in the operating menu enables results to be printed and print setup options to be set. The print setup menu enables the destination of the printouts and language of the printouts to be set. Depending on the measurement mode the printouts can be customized to print off post analysis statistics.

### 10.6.1 Print Setup

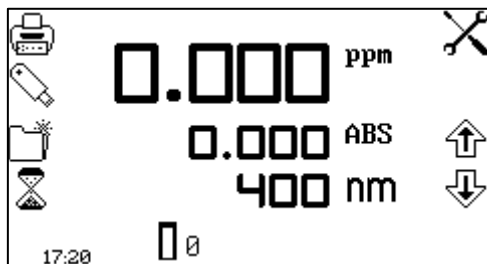

To open the print setup menu hold the key adjacent to the printer icon for 2 seconds in the operating menu.



To select the language for the printouts press the key adjacent to English icon. Repeat pressing of the key cycles the language between English, Français, Deutsche, Italiano and Espânôl.

The destination of the printouts can be the internal printer or an external serial printer. The results can only be sent to an external serial printer if there is a serial printer connected to the instrument via the RS232 serial port. Press the key adjacent to the computer icon to select the external serial printer. The results can only be sent to the internal printer if there is an internal printer connected. To select the internal printer for the printout destination press the key adjacent to the printer icon.

Once the required printout destination and language has been selected press the key adjacent to the tick icon to save and return to the operating menu.



### 10.6.1.1 Print Setup – PHOTOMETRICS AND CONCENTRATION

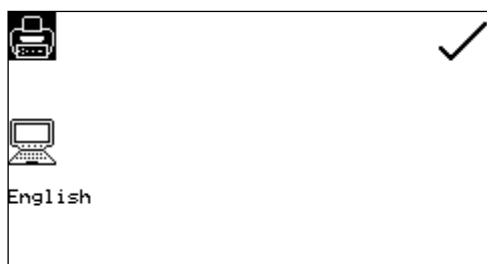

In the photometrics and concentration measurement modes the print setup menu does not contain any additional post analysis statistics.

### 10.6.1.2 Print Setup - SPECTRUM



In the spectrum measurement mode print setup menu it is possible to print off the spectral points analysis table, peaks and valleys data and absorbance or %T values recorded at certain data intervals. If the data interval is set to 5 every 5<sup>th</sup> data point recorded is reported. If no data is required the data interval can be set to zero.



To select the spectral points analysis table to be printed press the key adjacent to the spectral table icon. Repeat presses of the key will cycle between a tick and a cross icon for selected or deselected. To select the peaks and valleys data to be printed press the key adjacent to the peaks and valleys icon. To select the

data interval press the key adjacent to the data interval icon. Repeat presses will cycle between 0, 1, 2, 5, 10 or 50. Once the required options have been selected press the key adjacent to the tick icon to save and exit print-set up.

### 10.6.1.3 Print Setup – QUANTITATION

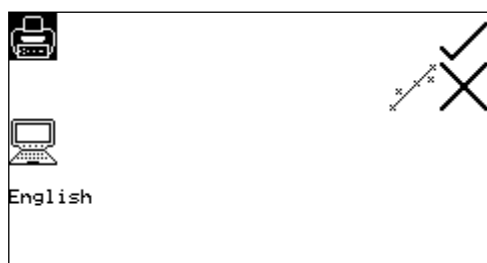

In the quantitation measurement mode print setup menu it is possible to print off the statistics for the standard curve. To select the curve statistics press the key adjacent to the curve statistics icon. Repeat presses of the key will cycle between a tick and a cross icon for selected or deselected.

Once the required options have been selected press the key adjacent to the tick icon to save and exit print-set up.

#### 10.6.1.4 Print Setup – KINETICS

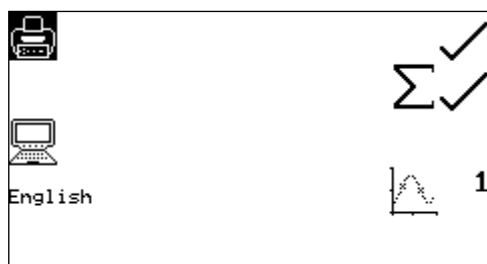

In the kinetics measurement mode print setup menu it is possible to print off the statistics for the whole kinetics experiment and the absorbance or % transmittance values recorded at certain data intervals. If the data interval is set to 10 every 10<sup>th</sup> data point recorded is reported. If no data is

required the data interval can be set to zero. To select the statistics to be printed press the key adjacent to the Σ icon. Repeat presses of the key will cycle between a tick and a cross icon for selected or deselected. To select the data interval press the key adjacent to the data interval icon. Repeat presses will cycle between 0, 1, 5, 10, 30 or 60 seconds.

Once the required options have been selected press the key adjacent to the tick icon to save and exit print-set up.

#### 10.6.2 Printing Results

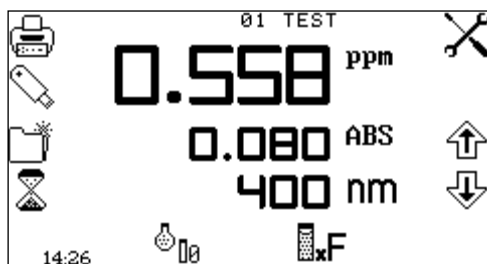

Results displayed in the operating menu can be printed by pressing the key adjacent to the printer icon. Any options selected in the print setup menu will also be reported when the printer icon is pressed. Depending on the printout destination selected the result will be sent to the internal printer or to the

external serial printer. If the printer icon is pressed when there is not a result on the screen the no result to printer or no result to RS232 icon (depending on results destination) will flash up on the screen.

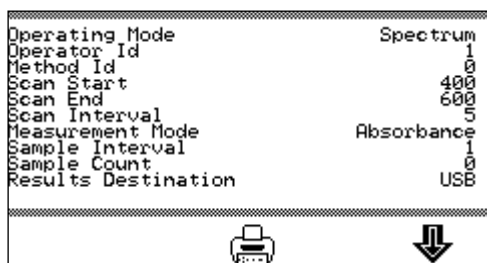

Saved results can be printed by pressing the key below the printer icon. The printout will include the date and time the result was generated, the user ID and the measurement parameters.

فروشگاه تخصصی آزمایشگاهی روناکو

## 10.7 AUTOLOGGING

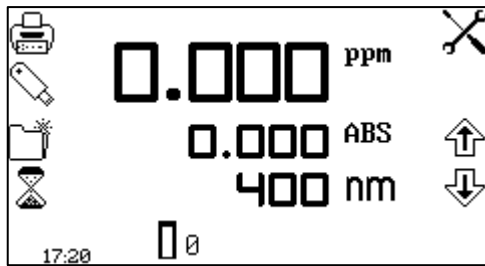

Operating Menu

The autolog function enables repeat measurements of the same sample to be performed with a set time period between each measurement. This produces a batch of results for the same sample. The autolog function also enables the results to be autologged to different destinations. The autolog menu is accessed from the utility toolbar in the operating menu by pressing the key adjacent to the autolog icon.

### 10.7.1 Setting the Number of Sample Repetitions

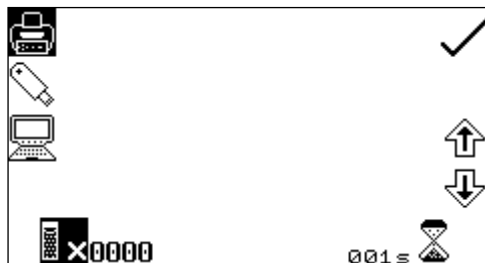

To set the number of repeat measurements of the same sample press the key below the sample icon and use the keys adjacent to the arrow icons to increase or decrease the number of repetitions required. To reset the number to zero press and hold the key below the sample icon for 2 seconds.

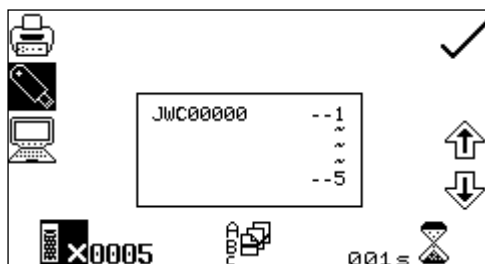

Once the number of repetitions is increased above zero, if the results are autologged to a USB memory stick, the batch ABC icon will be displayed. To assign a batch name for the repeated measurements press the key below the batch ABC icon to open the batch naming menu.



The default batch name will be displayed. To save the batch name under the default name press the key adjacent to the tick icon. To change the name press the key below the eraser icon. One press of the key will delete one letter, holding the key for 2 seconds will delete the name completely. To select letters use the

keys adjacent to the arrow icons to move around the menu. Once the required letter is highlighted press the key below the pencil icon to select the letter. Up to eight characters can be selected. To use numbers in the batch name press the key below the AB icon. Repeat pressing of this key will cycle between upper case and numbers. Once the required name for the batch has been entered press the key adjacent to the tick icon to save and return to the autolog menu.

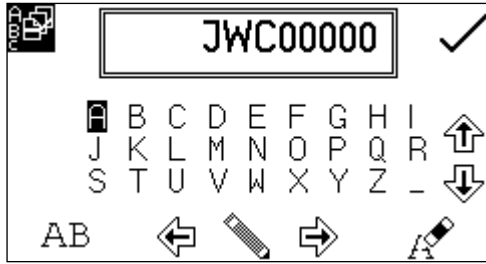

To set the time period between each measurement press the key below the timer icon and use the keys adjacent to the arrow icons to increase or decrease the time in 1 second intervals. To reset the time to one second press and hold the key below the timer icon for 2 seconds.

Once the required number of repetitions and time period has been selected press the key adjacent to the tick icon to save the changes and return to the operating menu.

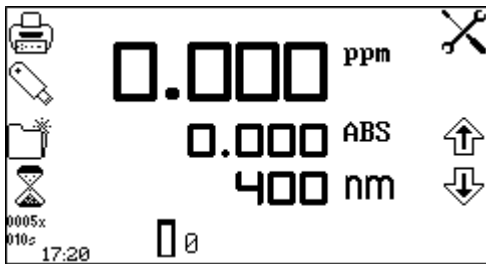

The number of repetitions and time period will be displayed below the autolog icon. To commence autologging press the key below the measure sample icon. Once the first measurement has been performed the time period starts counting down until it reaches zero and then the next measurement will be taken. This

will reduce the repetition number by one. When the number of repetitions reaches zero autologging is complete. Autologging can be stopped before all the measurements have been completed by pressing the key adjacent to the autolog icon. Confirmation will be needed to stop autologging. Press the key adjacent to the tick icon to confirm stopping autologging or press the key adjacent to the cross icon to continue autologging. If autologging is stopped before completion the measurements already recorded will be saved under the previously entered batch name.

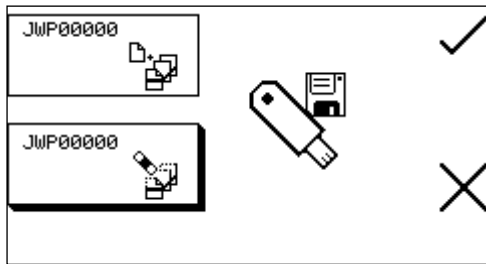

Once a set of results has been autologged to the USB memory stick when the measure sample key is pressed again the batch append/delete screen is displayed. Pressing the key adjacent to the batch append icon enables the next set of results to be added to the existing batch of results. Pressing the key adjacent to

the batch delete icon will delete the first set of results and replace them with the results that are going to be recorded. Press the key adjacent to the tick icon to confirm selection. Press the key adjacent to the cross icon to cancel and return to the operating menu.

### 10.7.2 Selecting Result's Destination



The autolog menu enables the result's destination to be set. To select the internal printer press the key adjacent to the printer icon. This option is only available if an internal printer is connected. To select the USB memory stick as the result's destination press the key adjacent to the USB memory stick icon. This option is

only available if a valid USB memory stick is connected to the instrument. To send the results to an external instrument such as a PC or a serial printer press the key adjacent to the computer icon.

## 10.8 CONNECTING TO A PC

Connect the interface cable to the RS232 serial port on the rear of the instrument and connect to the serial port on the rear of the PC. Turn the PC on and load the PC software by inserting the PC software disc into the CD drive. If the PC software does not auto run open My Computer and double click on the Jenway 73 series software icon. Follow the instructions to install the PC software to the required location. Refer to the PC software manual for further instructions. Once the software is installed turn the mains power on to the instrument.

The PC software is pre-configured to run using the following settings:

9600 baud

8 data bits

No parity

1 stop bit

فروشگاه تجهیزات آزمایشگاهی روناکو

## SECTION 11 – Accessories and Spare Parts

### 11.1 OPTIONAL ACCESSORIES

Part Code	Description of Accessory
660 101	Internal printer
735 401	Automatic 8 cell turret
735 201	Sipper pump
735 301	Peltier
735 701	Combined sipper Peltier pump
630 204	10x10mm path length cuvette holder
637 071	16/24mm test tube holder
630 005	10x100mm path length cuvette holder
630 304	10x10mm path length micro-cuvette holder
736 201	Water heated 10x10 single cell holder
035 088	Visible calibration set
035 091	UV/Visible calibration set
060 422	Moulded cuvette rack for 16 10x10mm cuvettes
735 001	Dust cover
019 146	4GB USB memory sticks for external memory
037 551	RS232 to USB converter for use with computer without a serial port

### 11.2 CONNECTING THE ACCESSORIES

There are two types of accessories which can be fitted in the sample chamber – passive or active accessories. The range of passive accessories includes 10 x 10mm single cuvette holders, single water heated cuvette holders, adjustable path length (10 to 100 mm) cuvette holders, test tube holders, boiling tube holders and micro-cuvette holders. The range of active accessories includes an automated 8 cell changer, sipper pump, Peltier and combined Peltier sipper pump. The instrument must be turned off before any accessories are fitted.

#### 11.2.1 INTERNAL PRINTER

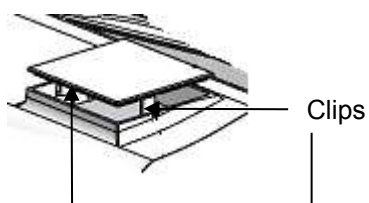

Use a small screw driver to lift the blanking panel on the top of the instrument. Squeeze the two clips in order to remove the blanking panel. Disconnect the printer wires which are secured to the underside of the blanking plate.



Unpack the printer from the packaging. Turn the printer upside down and connect the printer wires by clipping into the connector on the printer.

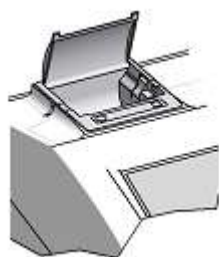

Squeeze the grey plastic clips together so that the printer top opens. Slot the printer into the top of the instrument and push down until it fits flush to all four sides.



Insert the paper roll into the printer – ensuring that there is some paper sticking out of the printer before clicking the grey plastic back into place. Switch the instrument on. The power and error lights on the printer will flash. Once the instrument power on tests are complete press the feed button to check that the paper is fed correctly.

### 11.2.2 PASSIVE ACCESSORIES

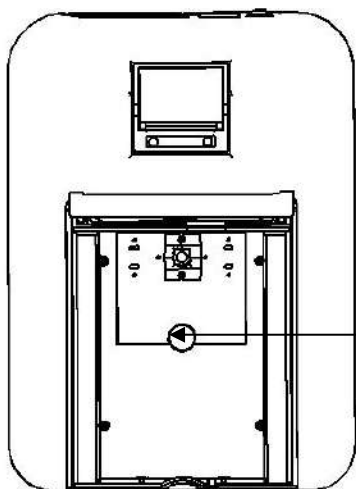

Thumb  
screw

Unscrew the thumb screw to undo the passive accessory. Lift out the passive accessory. To fit a different passive accessory simply place the accessory in the correct orientation, align the thumb screw and tighten to fix in place.

To replace the passive accessory with an active accessory refer to section 11.2.3.

فروشگاه تجهیزات آزمایشگاهی روناکو

### 11.2.2.1 Water-heated cuvette holder

The water heated cuvette holder is supplied with an additional front panel which also needs to be fitted.

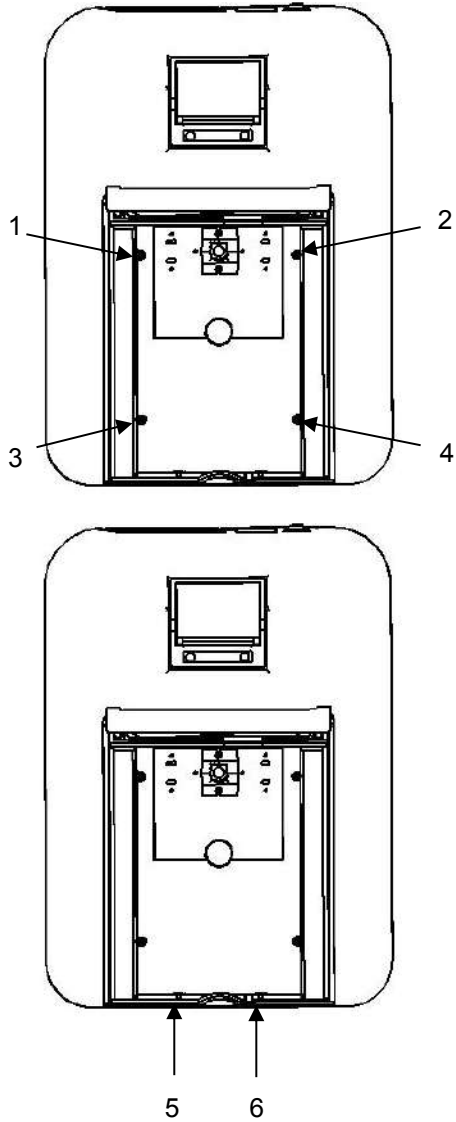

The water heated cuvette holder is already fitted to a base plate so the base plate in the instrument must be removed before installation. Unscrew screws 1 to 4 and lift out the metal base plate.

For this accessory as well as removing the passive accessory base plate, the front panel of the instrument must also be removed. Loosen screws 5 and 6 until the front panel can be lifted out in the forwards direction.

فروشگاه تجهیزات آزمایشگاهی روناکو



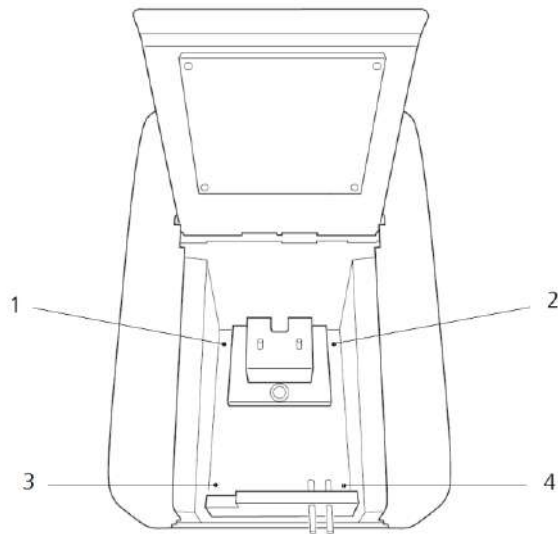

Once the base plate and front panel have been removed insert the water-heated cuvette holder into the chamber, ensuring the base plate rests flat in the unit. Replace the screws 1 to 4, securing the accessory in place.

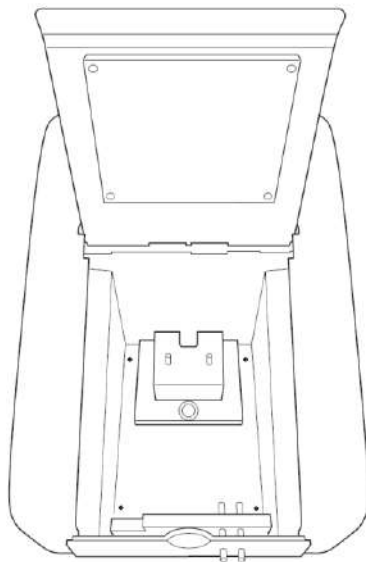

Fit the custom front panel to the unit ensuring the metal pipes on the accessory are aligned and fed through the two holes in the front panel. The metal pipes should protrude from the outer casing. Secure the custom accessory front plate to the unit with screws 5 and 6.

فروشگاه تجهیزات آزمایشگاهی روناکو

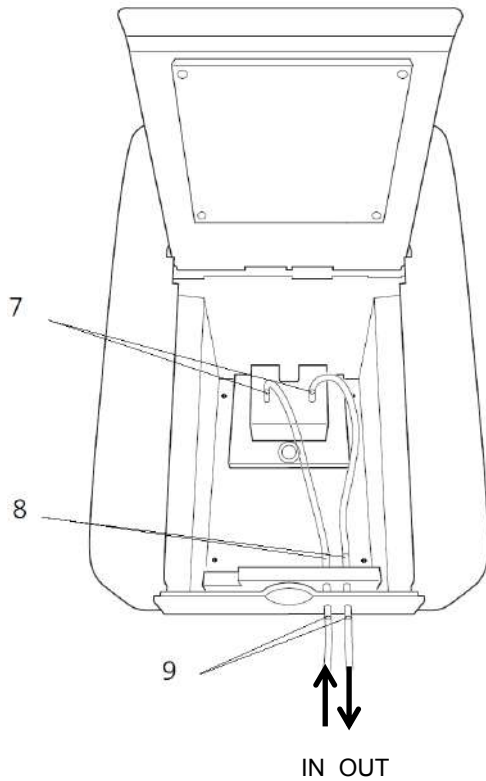

From the rubber tubing supplied, cut two shorter lengths of tubing and use these to connect the internal metal pipes of the cell block (7) to the internal metal pipes on the outer casing (8).

Using two separate pieces of rubber tubing connect the two external metal tubes (9) to an external water bath and pump. Ensure that the water is pumped **in** through the left hand side of the cell block and **out** through the right hand side of the cell block.

All tubing must be kept as short as possible and the tubing must not be allowed to obstruct the light path.

### 11.2.3 ACTIVE ACCESSORIES

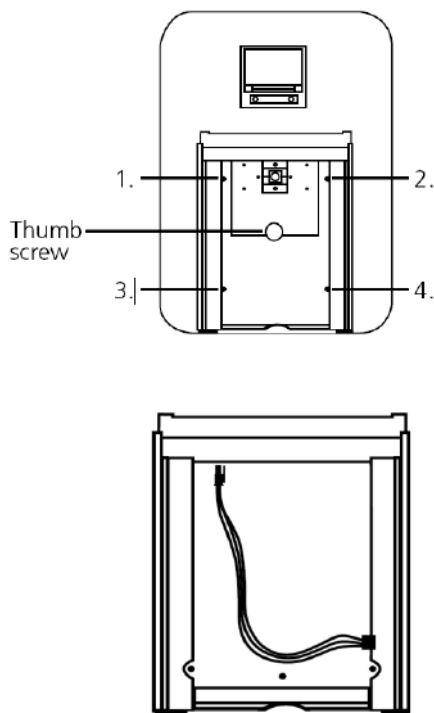

Unscrew the thumb screw to undo the passive accessory. Lift out the passive accessory. To fit an active accessory unscrew screws 1 to 4 and lift out the metal base plate.

This will expose the bottom of the sample chamber with the power supply connection needed to operate the active accessories.

فروشگاه تجهیزات آزمایشگاهی روناکو

### 11.2.3.1 Automatic 8 cell turret

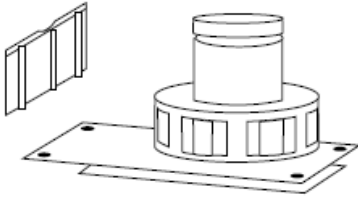

Take the 8 cell turret base plate. Connect the power supply in the bottom of the sample chamber to the connector on the underside of the base plate. Place the base plate in the sample chamber. Replace screws 1 to 4.

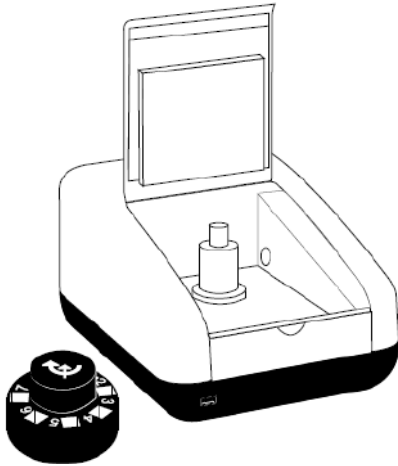

Take the 8 cell carousel and place on top of the motor, taking care to align the three ball bearings with the grooves on the motor shaft. Gently push the carousel down onto the motor shaft until it is located into place. Gently rotate the carousel until there is some resistance. The carousel is now in the correct position.

If the fitting is too tight use a small screw driver to loosen the ball bearings before pushing the

### 11.2.3.2 Peltier

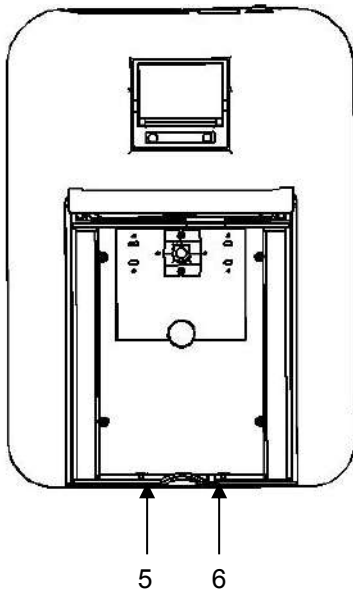

For this accessory as well as removing the passive accessory base plate, the front panel of the instrument must also be removed. Loosen screws 5 and 6 until the front panel can be lifted out in the forwards direction.

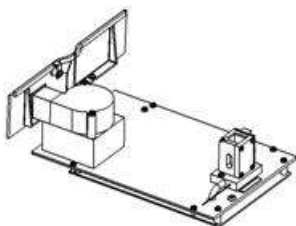

Take the Peltier base plate. Connect the power supply in the bottom of the sample chamber to the connector on the underside of the base plate. Place the base plate in the sample chamber. Replace screws 1 to 4. Take the Peltier front panel and slot into place

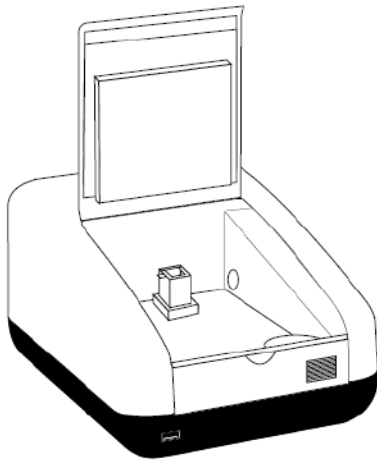

When the accessory is fitted the instrument will look like this.

### 11.2.3.3 Sipper pump

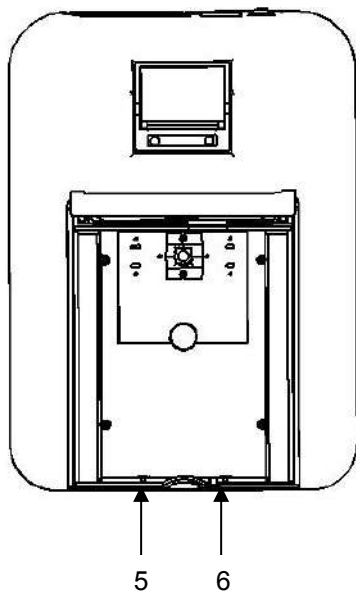

For this accessory as well as removing the passive accessory base plate, the front panel of the instrument must also be removed. Loosen screws 5 and 6 until the front panel can be lifted out in the forwards direction.

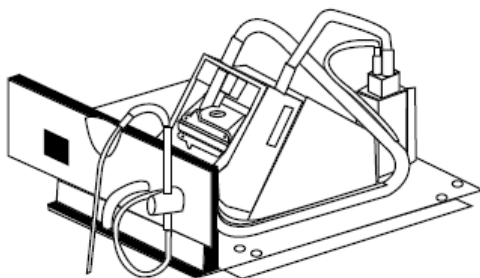

Take the sipper base plate. Connect the power supply in the bottom of the sample chamber to the connector on the underside of the base plate. Place the base plate in the sample chamber. Replace screws 1 to 4. Take the sipper Peltier front panel and slot into place before retightening screws 5 and 6.

فروشگاه تجهیزات آزمایشگاهی

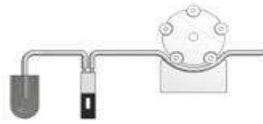

Bi directional flow A  
(sipping)

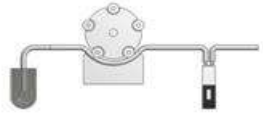

Bi directional flow B  
(pumping)

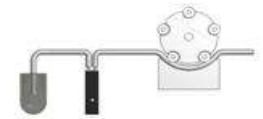

Continuous flow

The tubing should be connected depending on the function that the sipper pump is going to perform. All tubing must be kept as short as possible and the tubing must not be allowed to obstruct the light path.

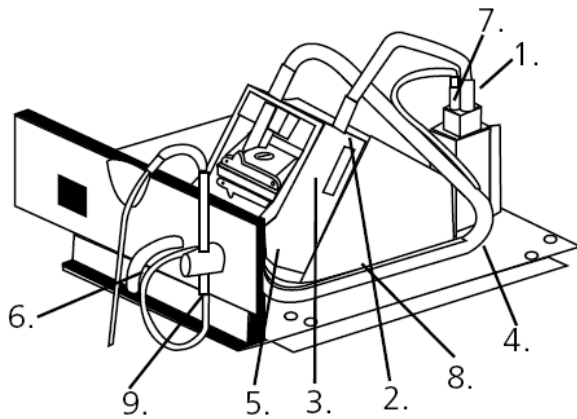

**For sipping:**

1. Connect the sipper pump tubing to the outlet port on the flow-through cuvette.
2. Secure the tubing using the clip on the righthand side of the pump head.
3. Ease the tubing round the rollers by carefully rotating them clockwise, by hand. Clamp the tubing into the clip on the left hand side of the motor.

4. Once secured, ensure the tubing is routed into the two retaining clips located on the base plate at the side of the pump head.
5. Cut the tubing at the point where it fits comfortably onto the left hand tube located on the inside of the front bulk head.
6. Connect a suitable length of this tubing to the external waste pipe.
7. Cut a small length of the sipper pump tube and push this over one end of the capillary tube. Connect this to the inlet port of the flow-through cuvette.
8. Route the tube into the two retaining clips located on the base plate at the side of the pump head.
9. Fit the sipper probe and secure using the thumbscrew. Feed the capillary tubing through the tube and up through the sipper probe, allowing sufficient length for it to pass into a suitable receptacle.

فروشگاه تجهیزات آزمایشگاهی روناکو

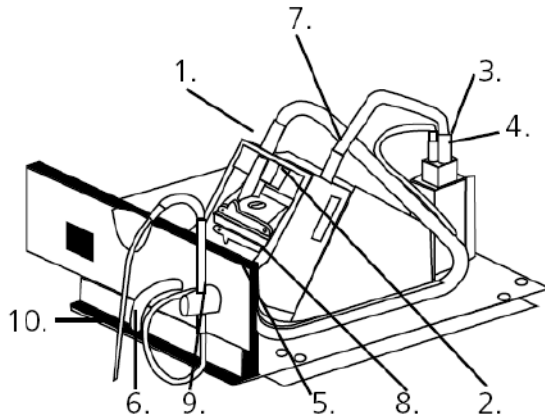

**For pumping:**

1. Cut two pieces of sipper pump tubing approximately 300mm in length. Take one length of tubing and fit this to the pump head, as shown, securing the tubing using the clip on the right hand side of the pump head.

2. Ease the tubing round the rollers carefully rotating them clockwise, by hand. Clamp the tubing into the clip on the left hand side of the motor.

3. Fit the other end onto the inlet port on the flow-through cuvette.

4. Fit the second 300mm length of tubing to the outlet port of the flow-through cuvette. Once secured, ensure the tubing is routed into the two retaining clips located on the base plate at the side of the pump head.

5. Fit the other end of the tubing onto the outlet port, located on the inside of the front bulkhead.

6. Connect a suitable length of sipper pump tubing to the external outlet port.

7. Insert one end of the capillary tube into the sipper pump tubing, as shown.

8. Feed the other end through the inlet port located on the inside of the bulkhead.

9. Fit the sipper probe and secure using the thumbscrew.

10. Carefully feed the tubing through the sipper probe, allowing sufficient length for it to pass into a suitable receptacle.

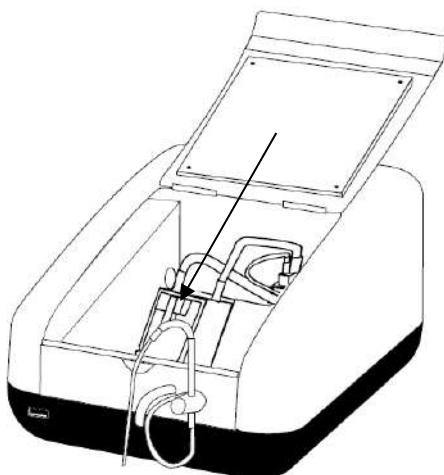

When the sipper accessory has been fitted and the tubing has been connected the instrument will look like this.

فروشگاه تجهیزات آزمایشگاهی روناکو

#### 11.2.3.4 Combined sipper Peltier pump

Refer to section 11.2.3.3 for more details.

### 11.3 USING THE ACCESSORIES

#### 11.3.1 Automatic 8 cell turret

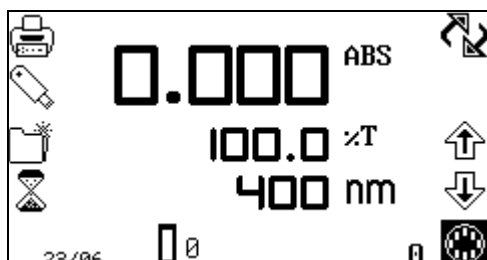

When the automatic 8 cell turret is in use the 8 cell turret icon is displayed in the bottom right hand corner of the screen. The current cell position is displayed adjacent to the 8 cell turret icon. The 0 position should always be used for the zero calibration sample.

To perform measurements using the automatic 8 cell turret, insert the cuvettes containing the samples into turret positions 1 to 7. Insert the cuvette containing the blank solution into turret position 0. Enter the required measurement mode and set up the required measurement parameters. Press the key below the calibrate to zero icon. The instrument will automatically move the turret around to position zero to perform the measurement. Once the calibration is complete the measure sample icon will appear and the turret will return to its original starting position.

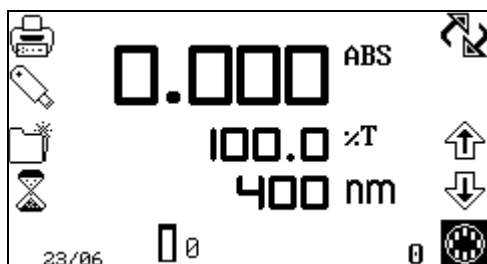

Press the key below the 8 cell turret icon to highlight the icon and the two arrow icons above. Press the keys adjacent to the arrow icons to increase or decrease the current cell position of the turret, until the required sample position has been selected. Press the key below the measure sample icon. The instrument will

perform a reading and display the result on the screen. To measure the next sample select the next turret position and press the key below the measure sample icon. Repeat this process until all the samples have been measured. To adjust the wavelength press the key below the 8 cell turret icon and use the arrow icons to adjust the wavelength.

#### 11.3.1.1 Automatic 8 cell turret – supporting creation of a standard curve in quantitation

The 8 cell turret can be used to support creation of a new standard curve in the quantitation measurement mode. Refer to section 8.2.3.1 for more details.

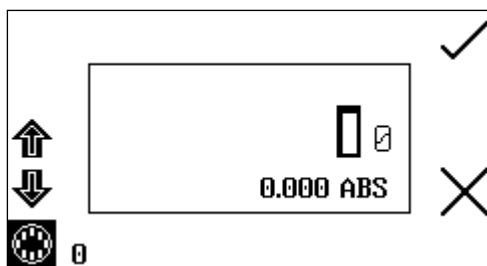

When the standard measurement screen is open the 8 cell turret icon will be displayed in the bottom left hand corner of the screen. The current cell position is displayed adjacent to the 8 cell turret icon. The 0 position should always be used for the zero calibration sample.

To measure the standards using the automatic 8 cell turret, insert the cuvettes containing the standards into turret positions 1 to 6 (depending on how many standards needed). Insert the cuvette containing the blank solution into turret position 0. Press the key adjacent to the tick icon to perform an initial calibration to zero absorbance.

Use the keys adjacent to the arrow icons to increase the turret position, until the required standard position has been selected. Press the key adjacent to the tick icon to measure the standard. The standard concentration and photometric value will then be displayed. The standard can be re-measured by pressing the key adjacent to the back icon.

To measure the next standard select the next turret position and press the key adjacent to tick icon. Repeat this process until all the standards have been measured.

### 11.3.2 Peltier

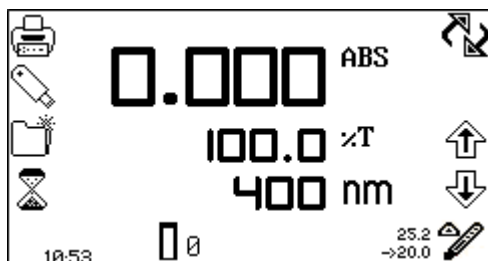

When the Peltier is in use the Peltier icon is displayed in the bottom right hand corner of the screen. The current temperature is displayed above the set point temperature adjacent to the Peltier icon. An arrow icon is displayed above or below the Peltier icon depending on if the current temperature is above or below the set

temperature. To adjust the set point temperature hold the key below the Peltier icon for 2 seconds.

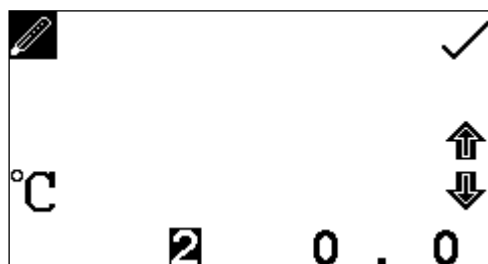

This opens the Peltier settings screen. Use the keys at the bottom of the screen to select the digit to be changed and use the arrow icons to increase or decrease the number. The temperature can be set in °C or °F by pressing the key adjacent to the °C icon.



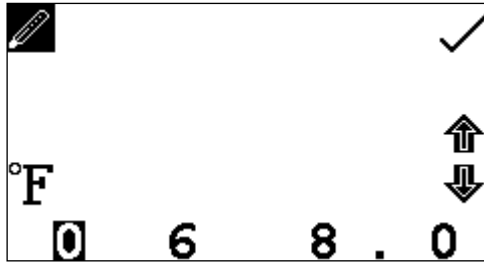

Repeat presses will cycle between °C and °F. Once the required temperature has been selected press the key adjacent to the tick icon to save and return to the operating menu. The Peltier will begin to heat or cool depending on the current temperature.

### 11.3.3 Sipper pump

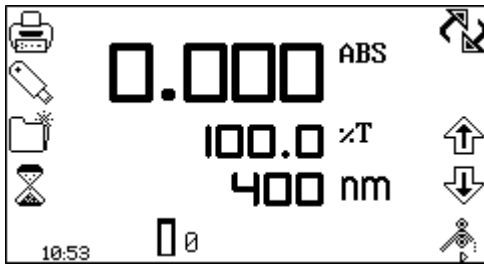

When the sipper is in use the sipper pump icon is displayed in the bottom right hand corner of the screen. The sipper pump can operate in manual or timed mode, depending on the option selected in sipper pump settings. If the manual mode is selected an arrow icon indicating pump direction will be displayed below the sipper pump icon.

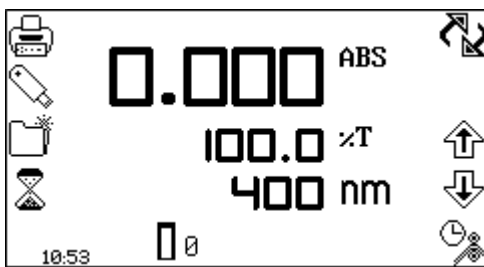

If the time mode is selected a clock icon will be displayed adjacent to the sipper pump icon.

To open the sipper pump settings hold the key below the sipper pump icon for 2 seconds.

#### 11.3.3.1 Manual Sipper Pump Settings

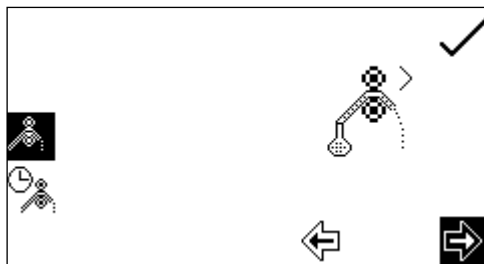

To operate the sipper pump in manual mode press the key adjacent to the manual sipper icon. Select the preferred pump direction by pressing the key below the forwards or backwards arrow. Press the key adjacent to the tick icon to save and return to the operating menu.

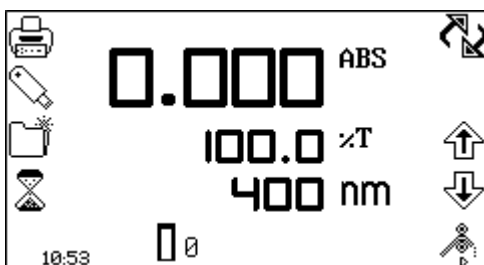

To perform a measurement place the sipper tubing into the sample and press the key below the sipper pump icon.

فروشگاه تجهیزات آزمایشگاهی روناکو

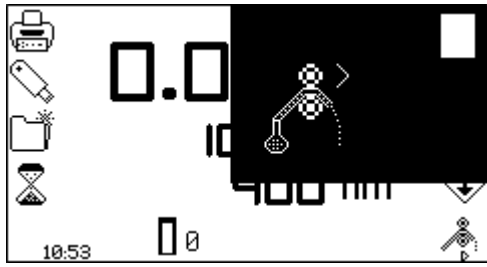

Confirmation will be needed to start the sipper pump. Press the key adjacent to the tick icon to confirm and start the sipper pump. Press the key adjacent to the cross icon to cancel and return to the operating menu.

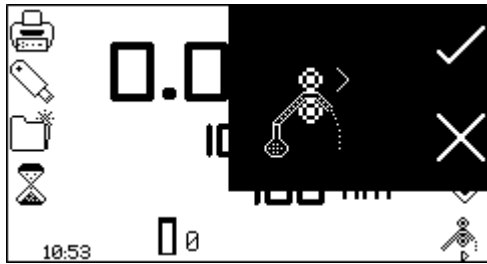

To stop the sipper pump press the key adjacent to the stop icon. Ensure that the flow through cuvette contains enough sample before pressing the key below the measure sample icon.

### 11.3.3.2 Timed Sipper Pump Settings

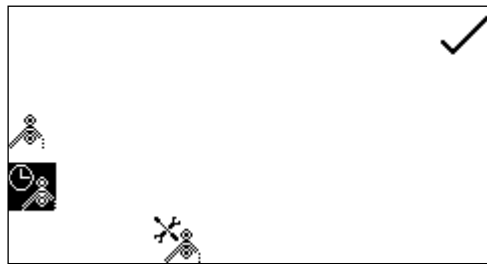

To operate the sipper pump in timed mode press the key adjacent to the timed sipper pump icon.

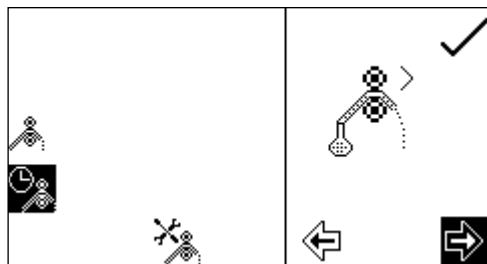

Press the key below the calibrate timed sipper icon. Select the required pump direction by pressing the key below the forwards or backwards arrow. Press the key adjacent to the tick icon to continue to the next stage of the calibration sequence.

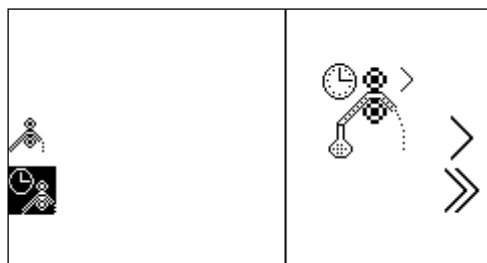

Insert the inlet tubing into the sample container and press the key adjacent to the single greater than icon. The sipper pump will start and the sample will be pumped through the tubing to the flow through cuvette. It is possible to skip this setup stage by pressing the key adjacent to the double greater than icon.

فروشگاه تجهیزات آزمایشگاهی روناسی

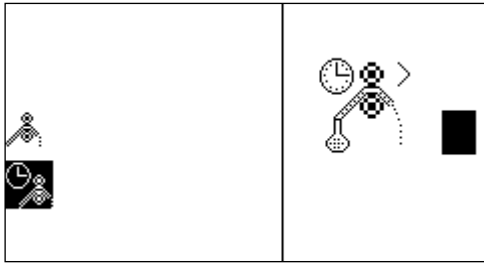

Once the cuvette is full press the key adjacent to the stop icon to stop the sipper pump. The time taken for sample uptake is recorded.

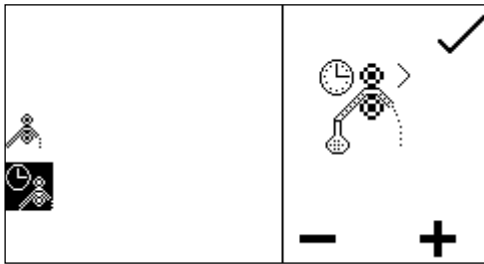

To fine tune the amount of sample uptake press the key below the plus or minus icon to increase or decrease the amount of sample taken up. The recorded time will be adjusted accordingly. Once the fine tuning is complete, or if none is required, press the key adjacent to the tick icon to move to the next stage of the calibration sequence.

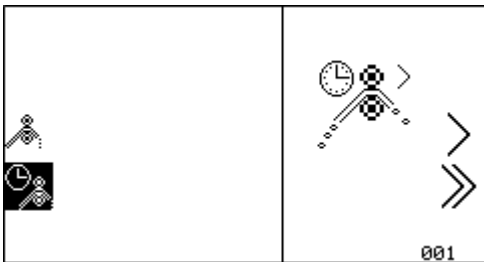

This stage allows an air gap to be added to the calibration sequence. If an air gap is not required press the key below the 001 icon to set the air gap to one. If a previously programmed air gap is to be used press the key adjacent to the double greater than icon to skip this stage and retain the current air gap time.

To program an air gap remove the inlet tubing from the sample container and press the key adjacent to the single greater than icon. The sipper pump will start and air will be pumped through the tubing to the flow through cell.

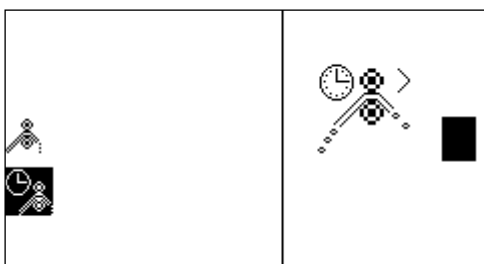

Once the required amount of air has been taken up press the key adjacent to the stop icon. The time taken for air uptake is recorded.

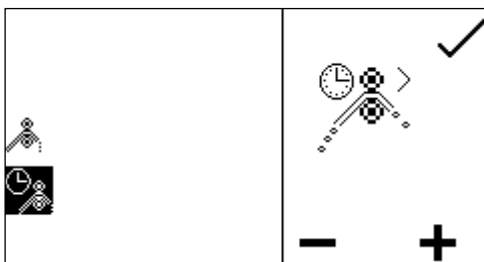

To fine tune the amount of air uptake press the key below the plus or minus icon to increase or decrease the amount of air taken in. The recorded time will be adjusted accordingly. Once the fine tuning is complete, or if none is required press the key adjacent to the tick icon to move to the next stage of the calibration sequence.

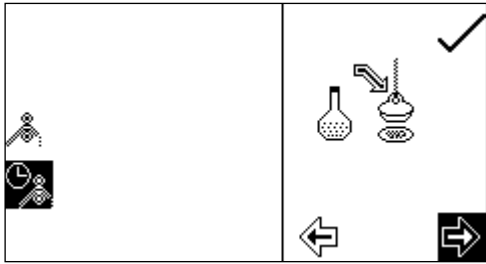

Once the sample uptake and air gap have been programmed the preferred disposal of the sample can be set. There are two options, the sample can either be sent back to the sample container or it can be sent to the waste pipe. Press the key below the forward or backward arrow to select what happens to the sample

after measurement. If the original pump direction selected was forwards, selecting the forwards direction at this stage will send the sample to waste and selecting the backwards direction will send the sample back to the sample container. Once the required direction has been selected press the key adjacent to the tick icon to save the calibration sequence and return to the operating menu. To exit the sipper calibration sequence without saving any changes press the back key at any point during the calibration sequence.

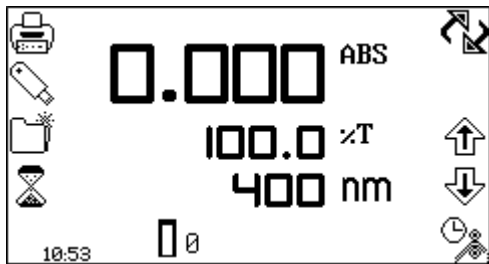

To perform a measurement place the sipper tubing into the sample and press the key below the sipper pump icon.

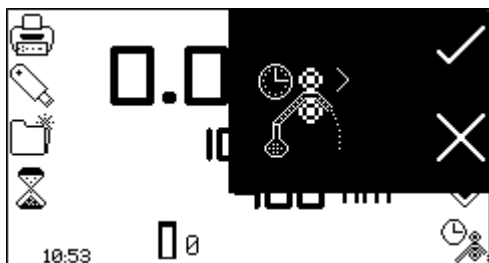

Confirmation will be needed to start the sipper pump. Press the key adjacent to the cross icon to cancel and return to the operating menu. Press the key adjacent to the tick icon to confirm and start the sipper pump. The pump will run for the previously recorded sample take up time. Ensure that the flow through

cuvette contains enough sample before pressing the key below the measure sample icon.

Once the measurement has been performed remove the tubing from the sample and press the key below the sipper pump icon to perform the next stage of the calibration sequence.

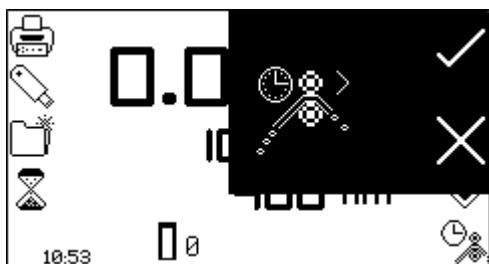

Confirmation will be needed to start the sipper pump. Press the key adjacent to the cross icon to cancel and return to the operating menu. Press the key adjacent to the tick icon to confirm and start the sipper pump. The pump will run for the previously recorded air gap take up time.

If an air gap of zero was previously selected this screen will not appear and the calibration

sequence will continue to sample disposal.

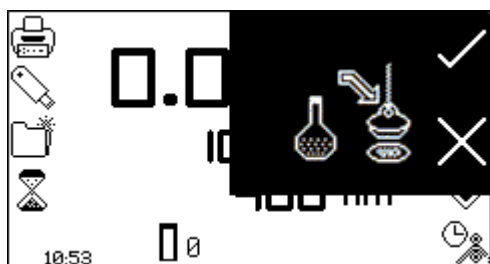

Once this stage of the calibration sequence is complete press the key below the sipper pump icon to dispose of the sample. Confirmation will be needed to start the sipper pump. Press the key adjacent to the cross icon to cancel and return to the operating menu. Press the key adjacent to the tick icon to confirm and

start the sipper pump. Depending on the disposal route previously selected the sample will either go to drain or back to the sample container.

### 11.3.4 Combined sipper Peltier pump

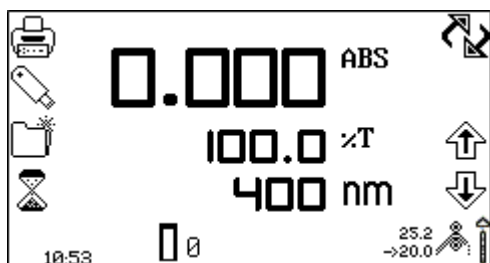

When the combined sipper Peltier is in use the sipper Peltier icon is displayed in the bottom right hand corner of the screen. The current temperature is displayed above the set point temperature adjacent to the sipper Peltier icon. Adjacent to the Peltier icon is an arrow to indicate if the current temperature is below or above

the set temperature. The pump direction is displayed by an arrow icon below the sipper Peltier icon. The combined sipper Peltier pump combines the functionality of the Peltier and sipper pump. To open the sipper Peltier settings hold the key below the sipper Peltier icon for 2 seconds.

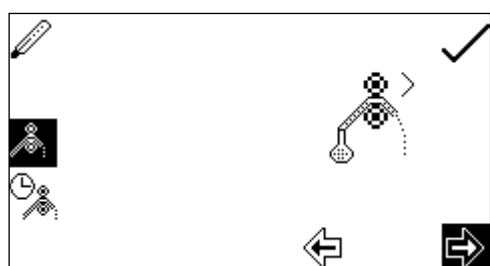

The settings menu is the same as the sipper pump settings except for the Peltier icon in the top left hand corner. Pressing the key adjacent to the Peltier icon will open the Peltier settings enabling the temperature to be set. Refer to section 11.3.2 for more details. The sipper pump can operate in a manual or timed mode. Refer to section 11.3 for more details.

## 11.4 SPARES

Part Code	Description of Spare Part
012 075	Tungsten halogen lamp
I/730 545	Xenon lamp module
630 204	10x10mm path length cuvette holder
060 084	Pack of 100 disposable plastic visible wavelength 10x10 cuvettes
060 230	Pack of 100 disposable plastic UV wavelength 10x10 cuvettes
037 702	Paper roll for printer
021 060	24V 65W power supply unit with various plug attachments

## SECTION 12 – Maintenance and Service

### 12.1 ROUTINE MAINTENANCE

Ensure the external surfaces of the unit are clean and free from dust. The sample area should always be kept clean and any accidental spillage should be wiped away immediately. To give added protection when not in use, the unit should be disconnected from the mains supply and covered with the optional dust cover.

The only routine maintenance which may be required is the replacement of the light source. The replacement lamps are available from your local distributor (refer to section 11.4 for spare part codes). Only genuine replacement lamps should be used. Similar lamps may have different filament configurations or be wavelength restricted for domestic or commercial use and will give errors if used.

### 12.2 LAMP REPLACEMENT

#### 12.2.1 Tungsten Halogen Lamp Replacement

This option is only valid for 7310 spectrophotometers.



Before replacing the lamp disconnect the unit from the mains supply and ensure the lamp is cool before handling. Access to the tungsten halogen lamp can be gained via the lamp access panel located on the rear of the instrument (refer to section 2.5).

1. Remove the screws holding the lamp access panel in place.
2. Withdraw the lamp access panel and unscrew the lamp bracket fixing screw.
3. Grasp and rotate the lamp bracket to gain access to the lamp.
4. Remove the old lamp from the holder. The lamp is a plug-in fit and should be removed by gently easing it from the holder.
5. Carefully remove the replacement lamp from the packaging. Ensure that the glass portion of the lamp is not touched as finger marks will damage the lamp resulting in a reduced performance. If accidental damage occurs the surface of the lamp may be cleaned using propan-2-ol.
6. Insert the lamp into the holder, ensuring it is fully pushed home.
7. Rotate the lamp bracket and put back into operational position. Replace the lamp bracket fixing screw and tighten.
8. Replace the lamp access panel and fix in place with the two screws.
9. Reconnect the power supply, turn on the unit and ensure that the lamp is illuminated after a few seconds.

For further instructions refer to the service manual.

### 12.2.2 Xenon Lamp Module Replacement



This option is only valid for the 7315 spectrophotometers and must be done by an accredited service engineer. Refer to section 12.3 for more details.

### 12.3 SERVICE

Our dedicated service staff are on hand to help in the unlikely event that your Jenway equipment develops a fault. Please contact them by one of the following means with a clear description of the problem:

E-mail: [cpSERVICE@coleparmer.com](mailto:cpSERVICE@coleparmer.com)

Tel: +44 (0) 1785 810475

On occasion it may be necessary for your equipment to be sent back to our Service Department for repair. In this case please contact the Service Department for a reference number which you should include with your faulty equipment. Please also ensure you include a clear description of the fault and a completed copy of our Decontamination Certificate. Please clearly mark the package for the attention of the Service Department and post to the following address:

Cole-Parmer Ltd  
Beacon Road  
Stone  
Staffordshire  
ST15 0SA  
United Kingdom











All replacement parts are guaranteed for 1 year and where ever possible, returned equipment is turned around in 10 working days.

فروشگاه تجهیزات آزمایشگاهی روناکو

## SECTION 13 – Troubleshooting

### 13.1 ERROR CODES

If an error code is displayed it will be accompanied by a spanner icon and a symbol to indicate if the error is a warning (caution icon) or fatal (stop icon). If the error is fatal contact your local distributor or Jenway service department (refer to section 12.3). If the error is a warning it may be possible to retry the test. In this case a back icon will also be displayed. The table below shows the error codes:

Error Code	Symbol	Issue
Err 1	  <b>Fatal</b>	<b>System Parameters Failure</b> This error indicates that the essential system parameters are corrupt. The most likely causes of this error are: 1. Fram chip failure. Solution: Restart the unit, if the problem persists contact a service technician.
Err 2	  <b>Warning</b> 	<b>Operating Parameters Failure</b> This error is a warning that the method and other user parameters have been reset. The most likely causes of this error are: 1. The methods were reset by pressing the top left button during the power on tests performed when the instrument is turned on. 2. The parameters have been corrupted so the instrument has reset itself. Solution: Press the key adjacent to the tick icon to action.
Err 3	  <b>Warning</b>  <b>Redo</b>	<b>Dark Calibration Error</b> This error indicates that the dark level is too high during calibration. In normal operation the lamp is switched off during an operator initiated calibration sequence to ensure that the detector output is below a threshold level. The calibration is aborted and Err 3 is displayed if the detector output is above the threshold level. The most likely causes of this error are: 1. The sample chamber lid has been left open during the calibration sequence. 2. The sample chamber lid was opened during the calibration sequence. 3. There is a fault on the detector PCB. Solution: Ensure the sample chamber is closed completely. Press the key adjacent to the back icon to retry the dark calibration.
Err 4	  <b>Fatal</b>	<b>Microswitch Failure (service only)</b> This error indicates that the microswitch was not found. The most likely causes of this error are: 1. The microswitch is broken. Solution: Contact a service technician.



Err 5



Fatal

#### Light Saturation Not Found

This error indicates that the peak light hasn't been found at zero.

The most likely causes of this error are:

1. Lamp failure.
2. Deteriorating lamp signal.
3. Sample or cuvette in the sample holder.

Solution:

Ensure the sample holder is empty. Restart the unit, if the problem persists contact a service technician.

Err 7



Warning



#### USB Module Failure

This error indicates the instrument is unable to detect a response from the UBS module.

The most likely causes of this error are:

1. USB port failure.

Solution:

Press the key adjacent to the tick icon to carry on using the instrument. Restart the unit, if the problem persists contact a service technician.

Err 8



Warning



#### Unable to find Vane on Turret

This error indicates that the vane position zero on the turret cannot be found.

The most likely causes for this error are:

1. The turret carousel has been removed and not replaced.

Solution:

Check if the turret is in the sample chamber and inserted properly. Press the key adjacent to the back icon to try rechecking.

Err 9



Fatal

#### Over Temperature

This error indicates that the thermal switch has cut out.

The most likely causes for this error are:

1. Failure of the fan
2. Thermal switch not connected.

Solution:

Restart the unit, if the problem persists contact a service technician.

### 13.2 TROUBLESHOOTING GUIDE

Issue	Solution
Unable to achieve zero absorbance or 100% transmittance when calibrating	Ensure that there is not a sample in the sample chamber. Ensure the instrument lid is closed before and during the calibration. Ensure the lamp is working – if the lamp has failed replace the lamp (7310) or lamp module (7315).
Unable to achieve a reading when measuring a sample	Ensure the correct cuvette is being used so that light isn't being absorbed by the cuvette. Ensure the sample isn't too dense that light is not transmitted through the sample. Ensure the lamp is working.
Unable to add additional points to the spectral points analysis table	The table can only hold 6 points. Delete one or more points before selecting additional points to add to the table.
Unable to print results using the internal printer	Ensure internal printer selected in autolog menu. Ensure there is paper in the unit. Ensure there is a result displayed on the screen.
Unable to save results to the USB memory stick	Ensure the USB stick is inserted into the front of the unit. Ensure the USB memory stick has free capacity. Ensure there is a result displayed on the screen.
Unable to continue kinetics measurement after cancelling abort action	Due to the nature of the kinetics measurements stopping the measurement before completion will result in some measurement time being lost. Therefore the experiment cannot be continued. It must be restarted.
The peaks and valleys table icon is not displayed following a spectrum scan	The peaks and valleys threshold is turned off. Change this value to 1%, 5% or 10% and the peaks and valleys table icon will be displayed.
The measure sample icon disappears after changing the wavelength	A calibration must be performed at the new wavelength. When the calibration is complete the measure sample icon will be displayed.
Unable to save methods	Ensure the method lock is not active.

### 13.3 TECHNICAL SUPPORT

Jenway have a dedicated Technical Support team made up of experienced scientists who are on hand to help with any applications advice and questions you may have about our products and how to use them. If you require any technical or application assistance please contact the team at:

E-mail: [cptechsupport@coleparmer.com](mailto:cptechsupport@coleparmer.com)

Phone: +44 (0)1785 810433

فروشگاه تجهیزات آزمایشگاهی روناکو

## SECTION 14 – Declaration of Conformity

**CE** This product meets the applicable EC harmonised standards for radio frequency interference and may be expected not to interfere with, or be affected by, other equipment with similar qualifications. We cannot be sure that other equipment used in its vicinity will meet these standards

and so we cannot guarantee that interference will not occur in practice. Where there is a possibility that injury, damage or loss might occur if equipment malfunctions due to radio frequency interference, or for general advice before use, contact the manufacturer.

**JENWAY**

**Cole-Parmer**

### EU Declaration of Conformity

<b>Product</b>	Laboratory Equipment	<b>File Number</b>	P225
<b>Manufacturer</b>	Cole-Parmer Ltd Beacon Road Stone, Staffordshire ST15 0SA United Kingdom		

This declaration of conformity is issued under the sole responsibility of the manufacturer

**Object of Declaration** UV-Visible Spectrophotometer Range - 73 Series  
(reference the attached list of catalogue numbers)

The object of the declaration described above is in conformity with the relevant Union Harmonisation Legislation:

<b>Low Voltage Directive</b>	2006/95/EC
<b>EMC Directive</b>	2004/108/EC
<b>RoHS Directive</b>	2011/65/EC

References to the relevant harmonised standards used or references to the other technical specifications in relation to which conformity is declared:

IEC/EN 61010-1:2001	Safety requirements for electrical equipment for measurement, control and laboratory use. Part 1: General requirements.
IEC/EN 61326-1:2006	Electrical equipment for measurement, control and laboratory use. EMC requirements. Part 1: General requirements (Class A).

Signed for and on behalf of the above manufacturer

**Additional Information** Year of CE Marking: 2010

**Place of Issue** Stone, Staffordshire, UK

**Date of Issue** April 2010. Revised 15 July 2012

**Authorised Representative** Steve Marriott

**Title** Technical Director



















**Signature** 





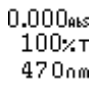

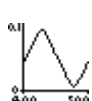









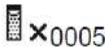



Declaration of Conformity is also available to view online at [www.jenway.com](http://www.jenway.com)

## SECTION 15 – Glossary of Icons





















Mode	ICON	Description
Common		Back key
Common		Tick icon - Done/yes
Common		Cross icon – Cancel/no
Common		Printer icon - Print/open printer settings
Common		No results to send to printer
Common		Computer icon - RS232 serial port for connection to an external serial printer or a computer
Common		No results to send to RS232
Common	English	English icon - Language selection
Common		USB memory stick
Common		Save method/result
Common		Load method/result
Common		Result already saved to USB memory stick
Common		Single method save icon
Common		1 – 48 method save icon
Common		Single method open icon
Common		1 – 48 method open icon
Common		Axis icon – View the result graphically
Common		ABC icon – View the results as a text file
Common		Arrow icon - Results page down, move left, decrease
Common		Arrow icon - Results page up, move right, increase
Common		Arrow icon – Move down, decrease
Common		Arrow icon – Move up, increase
Common		Calibrate to zero icon























فروشگاه تجهیزات آزمایشگاهی

Common		Pencil icon - Select letter/number
Common		Eraser icon - Delete letter/number
Common		AB icon - Change letter case/number
Common		Delete
Common		Method icon – opens method selection screen
Common		Units icon – opens unit selection screen
Common		Resolution
Common	400nm	Wavelength
Common	ABS/%T	Abs/%T icon - Operating mode either absorbance or % transmittance
Common		Lamp cold
Common		Lamp save
Common		Caution icon – accompanied by error code
Common		Check number
Common		Stop icon – accompanied by error code
Main Menu		Opens concentration measurement mode
Main Menu		Opens kinetics measurement mode
Main Menu		Opens photometrics measurement mode
Main Menu		Opens quantitation measurement mode
Main Menu		Opens spectrum measurement mode
Main Menu		Instrument settings















Main Menu	12.00	Time/date icon
Time & Date		Clock icon - Set time
Time & Date		Calendar icon - Set date
Time & Date		Toggle icon – Switches date format
Autolog		Autolog icon - Opens autolog menu
Autolog		Printer icon - Autolog to printer
Autolog		USB icon - Autolog to USB memory stick
Autolog		Computer icon - Autolog to computer or external serial printer through RS232 serial port
Autolog	 X0005	Sample icon - Number of sample measurement repetitions
Autolog	030s 	Timer icon - Time interval between each sample measurement repetition
Autolog		Batch ABC icon - Set batch name for repeated measurements
Autolog		Batch append – add existing results
Autolog		Batch delete – overwrite existing results
Instrument Settings		Closed padlock icon - Settings locked
Instrument Settings		Open padlock icon – Settings unlocked
Instrument Settings		Methods unlocked – method selection menu enabled
Instrument Settings		Methods locked – method selection menu disabled
Instrument Settings		Security code
Instrument Settings		Mode selection
Instrument Settings		Mode shown
Instrument Settings		Mode not shown
Instrument Settings		User ID
Instrument Settings		Contrast













فروشگاه تجهیزات آزمایشگاهی روناکو



Instrument Settings		Lamp save
Photometrics		Measure sample
Photometrics		Toggle icon – switches between ABS/%T
Concentration		Settings menu
Concentration		Measure to a factor
Concentration		Measure to a standard
Concentration	0.000 ABS	Calibrate to zero absorbance
Concentration	0.000 	Calibrate to a standard
Concentration		Calibrate to zero absorbance or standard
Concentration	<b>xF</b>	Factor menu
Concentration		Standard menu
Concentration	<b>001</b>	Resets standard or factor value to one
Concentration		Check standard
Spectrum		Scan settings menu
Spectrum		Hand icon – Manual y-axis scaling
Spectrum		Hand icon with cross through it - Auto y-axis scaling
Spectrum		Scan interval
Spectrum		Baseline scan
Spectrum		Baseline scan in progress
Spectrum		Scan sample
Spectrum		Sample scan in progress
Spectrum		Peaks and valleys threshold turned off
Spectrum		Peaks and valleys above threshold 5% are shown
Spectrum		Peaks and valleys table

Spectrum		Show peaks only
Spectrum		Show valleys only
Spectrum		Spectral points analysis
Spectrum		Double less than icon- decrease the wavelength by 10 times scan interval
Spectrum		Single less than icon - decrease the wavelength by 1 times scan interval
Spectrum		Double greater than icon - increase the wavelength by 10 times scan interval
Spectrum		Single greater than icon - increase the wavelength by 1 times scan interval
Spectrum		Wavelength icon - manually enter the wavelength
Spectrum		Add points to the spectral points analysis table
Spectrum		View spectral points analysis table
Spectrum		Data point interval – used in print setup
Quantitation		Measure sample
Quantitation		Quantitation table – Opens quantitation table
Quantitation		Number of standards
Quantitation		View standard curve
Quantitation		Curve fit – enables the curve fit to be adjusted
Quantitation		Sigma icon – Displays curve statistics
Quantitation		Create new standard curve
Quantitation		Tick icon - Read Standard
Quantitation		Back icon – Re-measure previous standard
Quantitation		Cross icon – Cancel creation of new standard curve
Quantitation		Curve statistics – used in print setup



Kinetics		Settings menu
Kinetics		Hand icon – Manual y-axis scaling
Kinetics		Hand icon with cross through it - Auto y-axis scaling
Kinetics		Start time pause – Opens lag time/start on level menu
Kinetics		001 - Resets lag time, standard or factor values to one
Kinetics		Clock icon - Set the lag time
Kinetics		ABS/%T icon - Set the start on level
Kinetics		Greater than - Start above
Kinetics		Less than - Start below
Kinetics		No start on level set
Kinetics		Start kinetics measurement
Kinetics		Kinetics measurement in progress
Kinetics		Sigma icon - Post measurement statistics
Kinetics		Kinetics moving line
Kinetics		Update factor in settings
Kinetics		Toggle icon – switches between the initial and final point lines
Kinetics		Double less than icon - Decrease the time by 5 seconds intervals
Kinetics		Single less than icon - Decrease the time by 1 second intervals
Kinetics		Double greater than icon - Increase the time by 5 seconds intervals
Kinetics		Single greater than icon - Increase the time by 1 second intervals
Kinetics		Data point interval – used in print settings

Accessories		No single cell - Method created on a unit with a single cell accessory fitted
Accessories		8 cell turret icon – the automatic 8 cell turret is in use
Accessories		Error finding cell position 0 on turret
Accessories		No turret - Method created on a unit with a turret accessory fitted
Accessories	°C	Degrees Celsius
Accessories	°F	Degrees Fahrenheit
Accessories		Peltier accessory in use – current temperature is below set point. The current temperature is displayed above set point temperature
Accessories		No Peltier - Method created on a unit with a Peltier accessory fitted
Accessories		Sipper pump in use – running in forward direction
Accessories		Sipper pump in use – running in reverse direction
Accessories		Timed sipper pump
Accessories		Timed sipper pump calibration sequence
Accessories	>	Start sipper pump – enables take up time to be set
Accessories	>>	Skip take up time – uses the previously set take up time
Accessories	001	001 – sets air gap to one
Accessories	■	Stop sipper pump
Accessories	—	Reduce sample uptake/reduce air gap
Accessories	+	Increase sample uptake/increase air gap
Accessories		No sipper - Method created on a unit with a sipper accessory fitted
Accessories		Sipper Peltier pump in use

Accessories		No sipper Peltier - Method created on a unit with a sipper Peltier accessory fitted
Accessories		PC comms - shown when the instrument is connected to a PC and communicating via the PC software
Error		Spanner – refer to section 13

فروشگاه تجهیزات آزمایشگاهی روناکو



Thank you for reading this data sheet.

For pricing or for further information, please contact us at our UK Office, using the details below.



**UK Office**

**Keison Products,**

**P.O. Box 2124, Chelmsford, Essex, CM1 3UP, England.**

**Tel: +44 (0)330 088 0560**

**Fax: +44 (0)1245 808399**

**Email: [sales@keison.co.uk](mailto:sales@keison.co.uk)**

Please note - Product designs and specifications are subject to change without notice. The user is responsible for determining the suitability of this product.

فروشگاه تجهیزات آزمایشگاهی روناک